

ETSI EN 300 328 V2.1.1 (2016-11)

TEST REPORT

For

High-Flying Electronics Technology Co., Ltd.

Room 1002, Building 1, No.3000, Longdong Avenue, Pudong New Area, Shanghai, China

Tested Model: HF2211

Report Type: Original Report	Product Type: WIFI Serial Device Server
Test Engineer: <u>Ada Yu</u>	<i>Ada Yu</i>
Report Number: <u>RKS170630005-00B</u>	
Report Date: <u>2017-07-17</u>	
Reviewed By: <u>Oscar Ye RF Leader</u>	<i>Oscar Ye</i>
Prepared By: Bay Area Compliance Laboratories Corp. (Kunshan) No.248 Chenghu Road,Kunshan, Jiangsu province, China Tel: +86-0512-86175000 Fax: +86-0512-88934268 www.baclcorp.com.cn	

Note: This test report is prepared for the customer shown above and for the equipment described herein. It may not be duplicated or used in part without prior written consent from Bay Area Compliance Laboratories Corp. This report is valid only with a valid digital signature. The digital signature may be available only under the Adobe software above version 7.0.

TABLE OF CONTENTS

GENERAL INFORMATION.....	4
PRODUCT DESCRIPTION FOR EQUIPMENT UNDER TEST (EUT).....	4
OBJECTIVE	4
RELATED SUBMITTAL(S)/GRANT(S).....	4
TEST METHODOLOGY	4
MEASUREMENT UNCERTAINTY.....	5
TEST FACILITY	5
SYSTEM TEST CONFIGURATION.....	6
DESCRIPTION OF TEST CONFIGURATION	6
EUT EXERCISE SOFTWARE	6
SPECIAL ACCESSORIES.....	6
EQUIPMENT MODIFICATIONS	6
SUPPORT EQUIPMENT LIST AND DETAILS	7
EXTERNAL I/O CABLE.....	7
BLOCK DIAGRAM OF TEST SETUP	7
SUMMARY OF TEST RESULTS	8
TEST EQUIPMENT LIST	9
ETSI EN 300 328 V2.1.1 (2016-11) Clause 4.3.2.2 – RF OUTPUT POWER.....	10
APPLICABLE STANDARD	10
TEST PROCEDURE	10
TEST DATA	11
ETSI EN 300 328 V2.1.1 (2016-11) Clause 4.3.2.3 - POWER SPECTRAL DENSITY	14
APPLICABLE STANDARD	14
TEST PROCEDURE	14
TEST SETUP BLOCK DIAGRAM.....	17
TEST DATA	17
ETSI EN 300 328 V2.1.1 (2016-11) Clause 4.3.2.6 – ADAPTIVITY	22
APPLICABLE STANDARD	22
TEST PROCEDURE	22
TEST SETUP BLOCK DIAGRAM.....	22
TEST DATA	23
ETSI EN 300 328 V2.1.1 (2016-11) Clause 4.3.2.7 – OCCUPIED CHANNEL BANDWIDTH	27
APPLICABLE STANDARD	27
TEST PROCEDURE	27
TEST DATA	28
ETSI EN 300 328 V2.1.1 (2016-11) Clause 4.3.2.8 – TRANSMITTER UNWANTED EMISSION IN THE OUT-OF-BAND DOMAIN.....	33
APPLICABLE STANDARD	33
TEST PROCEDURE	33
TEST DATA	35
ETSI EN 300 328 V2.1.1 (2016-11) Clause 4.3.2.9 – TRANSMITTER UNWANTED EMISSION IN THE SPURIOUS DOMAIN.....	40

APPLICABLE STANDARD	40
TEST PROCEDURE	40
TEST DATA	42
ETSI EN 300 328 V2.1.1 (2016-11) Clause 4.3.2.10 – RECEIVER SPURIOUS EMISSIONS.....	43
APPLICABLE STANDARD	43
TEST PROCEDURE	43
TEST DATA	45
ETSI EN 300 328 V2.1.1 (2016-11) Clause 4.3.2.11 – RECEIVER BLOCKING.....	46
APPLICABLE STANDARD	46
TEST PROCEDURE	47
TEST SETUP BLOCK DIAGRAM.....	48
TEST DATA	48
EXHIBIT A - E.1 INFORMATION AS REQUIRED BY ETSI EN 300 328 V2.1.1, CLAUSE 5.4.1	50
EXHIBIT B - EUT PHOTOGRAPHS	55
EUT – FRONT VIEW	55
EUT – REAR VIEW	55
EUT – TOP VIEW.....	56
EUT – BOTTOM VIEW	56
EUT – LEFT VIEW	57
EUT – RIGHT VIEW.....	57
EUT – COVER OFF VIEW–1	58
EUT – COVER OFF VIEW–2	58
EUT – COVER OFF VIEW–3	59
EUT – COVER OFF VIEW–4	59
EUT – PCB TOP VIEW	60
EUT – PCB TOP SHIELDING OFF VIEW	60
EUT – PCB BOTTOM VIEW.....	61
EUT – WI-FI MODULE TOP VIEW	61
EUT – WI-FI MODULE BOTTOM VIEW.....	62
EXHIBIT C - TEST SETUP PHOTOGRAPHS.....	63
RADIATED SPURIOUS EMISSIONS TEST VIEW (BELOW 1GHZ).....	63
RADIATED SPURIOUS EMISSIONS TEST VIEW (ABOVE 1GHZ)	63

GENERAL INFORMATION

Product Description for Equipment under Test (EUT)

Applicant	High-Flying Electronics Technology Co., Ltd.
Tested Model	HF2211
Product Type	WIFI Serial Device Server
Dimension	95 mm(L)×65 mm(W)×25 mm(H)
Power Supply	DC 5-36V

**All measurement and test data in this report was gathered from production sample serial number: 20170630003.
(Assigned by the BACL. The EUT supplied by the applicant was received on 2017-06-30)*

Objective

This report is prepared on behalf of High-Flying Electronics Technology Co., Ltd. in accordance with ETSI EN 300 328 V2.1.1 (2016-11), Wideband transmission systems; Data transmission equipment operating in the 2, 4 GHz ISM band and using wide band modulation techniques; Harmonised Standard covering the essential requirements of article 3.2 of Directive 2014/53/EU

The objective is to determine the compliance of EUT with ETSI EN 300 328 V2.1.1 (2016-11).

Related Submittal(s)/Grant(s)

No related submittal(s).

Test Methodology

All measurements contained in this report were conducted with ETSI EN 300 328 V2.1.1 (2016-11).

Measurement Uncertainty

Item		Uncertainty
RF Output Power with Power meter		0.5dB
Power Spectral Density, conducted		0.5dB
Unwanted Emissions, conducted		2.34 dB
Radiated emission	30MHz~1GHz	5.91dB
	1GHz~6GHz	4.68dB
	6 GHz ~18 GHz	4.92dB
	18 GHz~40 GHz	4.88dB
Occupied Bandwidth		0.5kHz
Temperature		1.0°C
Humidity		6%
Time		5 %
Supply voltages		0.04%

Test Facility

The test site A used by Bay Area Compliance Laboratories Corp. (Kunshan) to collect test data is located on the No.248 Chenghu Road, Kunshan, Jiangsu province, China.

Test site at Bay Area Compliance Laboratories Corp. (Kunshan) has been fully described in reports submitted to the Federal Communication Commission (FCC). The details of these reports have been found to be in compliance with the requirements of Section 2.948 of the FCC Rules on November 06, 2014. The facility also complies with the radiated and AC line conducted test site criteria set forth in ANSI C63.4-2014.

The Federal Communications Commission has the reports on file and is listed under FCC Registration No.: 815570. The test site has been approved by the FCC for public use and is listed in the FCC Public Access Link (PAL) database.

SYSTEM TEST CONFIGURATION

Description of Test Configuration

For 802.11b, 802.11g and 802.11n-HT20 mode, 13 channels are provided to testing, EUT was tested with Channel 1, 7 and 13.

For 802.11n-HT40 mode, 11 channels are provided to testing, EUT was tested with Channel 3, 7 and 11.

Channel	Frequency (MHz)	Channel	Frequency (MHz)
1	2412	8	2447
2	2417	9	2452
3	2422	10	2457
4	2427	11	2462
5	2432	12	2467
6	2437	13	2472
7	2442	/	/

The worst-case data rates are determined to be as follows for each mode based upon investigation by measuring the average power and PSD across all data rates bandwidths, and modulations.

EUT Exercise Software

RF test tool: Ralink QA Test Program

The worst condition was performed under:

Mode	Data rate	Power level
802.11b	1 Mbps	13
802.11g	6 Mbps	11
802.11n-HT20	MCS0	11
802.11n-HT40	MCS0	10

Special Accessories

No special accessory.

Equipment Modifications

No modification was made to the EUT.

Support Equipment List and Details

Manufacturer	Description	Model	Serial Number
DELL	Notebook	GX620	D65874152
Lenovo	Adapter	ADP-65KH B	/

External I/O Cable

Cable Description	Length (m)	From Port	To
RJ45 Cable	0.8	EUT	Notebook
RS232 Cable	1.0	EUT	Notebook

Block Diagram of Test Setup

For Radiated Emissions(Below 1GHz&Above 1GHz):

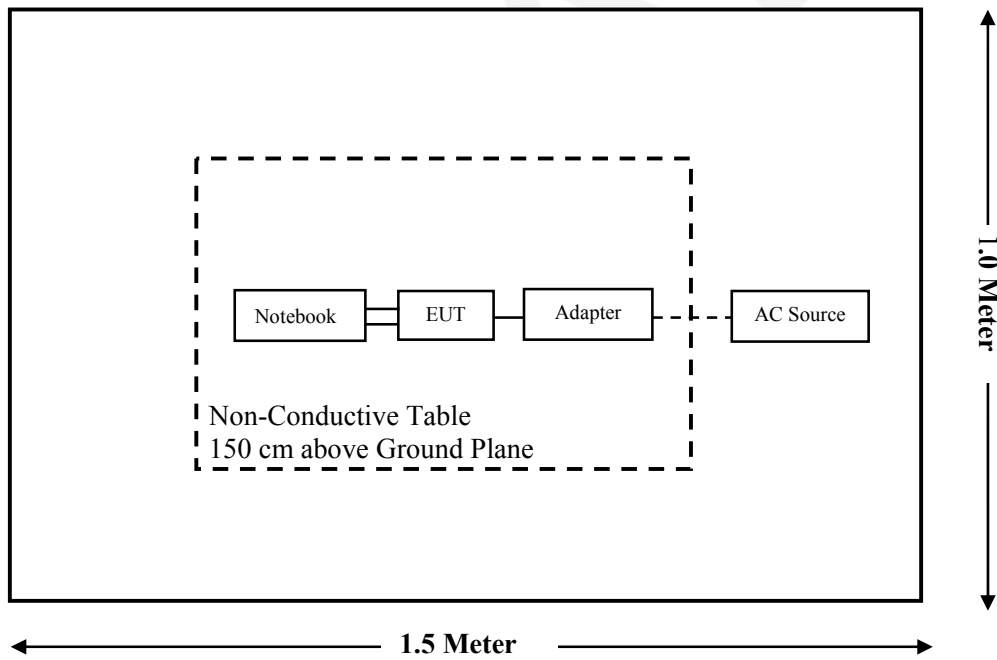

SUMMARY OF TEST RESULTS

ETSI EN 300 328 V2.1.1 (2016-11)	Description of Test	Test Result
Clause 4.3.2.2	RF output power	Compliance
Clause 4.3.2.3	Power Spectral Density	Compliance
Clause 4.3.2.4	Duty Cycle, Tx-sequence, Tx-gap	Not Applicable (See Note1)
Clause 4.3.2.5	Medium Utilisation (MU) factor	Not Applicable (See Note1)
Clause 4.3.2.6	Adaptivity	Compliance
Clause 4.3.2.7	Occupied Channel Bandwidth	Compliance
Clause 4.3.2.8	Transmitter unwanted emissions in the out-of-band domain	Compliance
Clause 4.3.2.9	Transmitter unwanted emissions in the spurious domain	Compliance
Clause 4.3.2.10	Receiver spurious emissions	Compliance
Clause 4.3.2.11	Receiver Blocking	Compliance
Clause 4.3.2.12	Geo-location capability	Not Applicable (See Note2)

Note1: This item is only for non-adaptive mode.

Note2: The supplier declared that the equipment is unable to perform this function.

TEST EQUIPMENT LIST

Manufacturer	Description	Model	Serial Number	Calibration Date	Calibration Due Date
Radiated Emission Test					
Rohde & Schwarz	EMI Test Receiver	ESCI	100195	2016-11-25	2017-11-24
HP	Signal Generator	8341B	DE23437	2016-08-29	2017-08-28
Rohde & Schwarz	Signal Analyzer	FSIQ26	100048	2016-11-25	2017-11-24
Sunol Sciences	Broadband Antenna	JB3	A040914-2	2016-01-09	2019-01-08
Sunol Sciences	Broadband Antenna	JB3	A090314-2	2016-01-09	2019-01-08
ETS-LINDGREN	Horn Antenna	3115	9311-4159	2016-01-11	2019-01-10
ETS-LINDGREN	Horn Antenna	3115	6229	2016-01-11	2019-01-10
Sonoma Instrument	Pre-amplifier	330	171377	2016-12-12	2017-12-11
Narda	Pre-amplifier	AFS42-00101800	2001270	2016-12-12	2017-12-11
Rohde & Schwarz	Auto test Software	EMC32	100361	/	/
Haojintech	Coaxial Cable	Cable-1	001	2016-12-12	2017-12-11
Haojintech	Coaxial Cable	Cable-2	002	2016-12-12	2017-12-11
Haojintech	Coaxial Cable	Cable-3	003	2016-12-12	2017-12-11
MICRO-COAX	Coaxial Cable	Cable-4	004	2016-12-12	2017-12-11
MICRO-COAX	Coaxial Cable	Cable-5	005	2016-12-12	2017-12-11
MICRO-COAX	Coaxial Cable	Cable-7	007	2016-12-12	2017-12-11
RF Conducted Test					
Rohde & Schwarz	OSP120 Base Unit	OSP120	101247	2017-07-04	2018-07-03
BACL	EMC32 Version	EMC32	09106	/	/
Rohde & Schwarz	SMBV100A Vector Signal Generator	SMBV100A	261558	2017-07-04	2018-07-03
Rohde & Schwarz	SMB 100A Signal Generator	SMB100A	110390	2017-07-04	2018-07-03
HP	Attenuator/11dB	8494B	N/A	2017-01-10	2018-01-09
Agilent	Attenuator/110dB	8496B	N/A	2017-01-10	2018-01-09
Rohde & Schwarz	Signal Analyzer	FSIQ26	836131/009	2016-09-21	2017-09-20
R & S	Wideband Radio Communication Tester	CMW500	116218	2016-10-08	2017-10-07
BACL	Temperature & Humidity Chamber	BTH-150	30023	2016-10-10	2017-10-09
High-Flying	RF Cable	N/A	N/A	2017-07-06	2018-07-05

* **Statement of Traceability:** Bay Area Compliance Laboratories Corp. (Kunshan) attests that all calibrations have been performed in accordance to requirements that traceable to National Primary Standards and International System of Units (SI).

ETSI EN 300 328 V2.1.1 (2016-11) Clause 4.3.2.2 – RF OUTPUT POWER

Applicable Standard

The RF output power is defined as the mean equivalent isotropically radiated power (e.i.r.p.) of the equipment during a transmission burst.

Limit

For adaptive equipment using wide band modulations other than FHSS, the maximum RF output power shall be 20 dBm.

The maximum RF output power for non-adaptive equipment shall be declared by the manufacturer and shall not exceed 20 dBm. See clause 5.4.1 m). For non-adaptive equipment using wide band modulations other than FHSS, the maximum RF output power shall be equal to or less than the value declared by the manufacturer.

This limit shall apply for any combination of power level and intended antenna assembly.

Test Procedure

The test procedure shall be as follows:

Step 1:

- Use a fast power sensor suitable for 2,4 GHz and capable of minimum 1 MS/s.
- Use the following settings:
 - Sample speed 1 MS/s or faster.
 - The samples shall represent the RMS power of the signal.
 - Measurement duration: For non-adaptive equipment: equal to the observation period defined in clause 4.3.1.3.2 or clause 4.3.2.4.2. For adaptive equipment, the measurement duration shall be long enough to ensure a minimum number of bursts (at least 10) is captured.

NOTE 1: For adaptive equipment, to increase the measurement accuracy, a higher number of bursts may be used.

Step 2:

- For conducted measurements on devices with one transmit chain:
 - Connect the power sensor to the transmit port, sample the transmit signal and store the raw data. Use these stored samples in all following steps.
- For conducted measurements on devices with multiple transmit chains:
 - Connect one power sensor to each transmit port for a synchronous measurement on all transmit ports.
 - Trigger the power sensors so that they start sampling at the same time. Make sure the time difference between the samples of all sensors is less than 500 ns.
 - For each individual sampling point (time domain), sum the coincident power samples of all ports and store them. Use these summed samples as the new stored data set.

Step 3:

- Find the start and stop times of each burst in the stored measurement samples.
The start and stop times are defined as the points where the power is at least 30 dB below the highest value of the stored samples in step 2.

NOTE 2: In case of insufficient dynamic range, the value of 30 dB may need to be reduced appropriately.

Step 4:

- Between the start and stop times of each individual burst calculate the RMS power over the burst using the formula below. The start and stop points shall be included. Save these P_{burst} values, as well as the start and stop times for each burst.

$$P_{burst} = \frac{1}{k} \sum_{n=1}^k P_{sample}(n)$$

With 'k' being the total number of samples and 'n' the actual sample number

Step 5:

- The highest of all P_{burst} values (value "A" in dBm) will be used for maximum e.i.r.p. calculations.

Step 6:

- Add the (stated) antenna assembly gain "G" in dBi of the individual antenna.
- If applicable, add the additional beamforming gain "Y" in dB.
- If more than one antenna assembly is intended for this power setting, the maximum overall antenna gain (G or G + Y) shall be used.
- The RF Output Power (P) shall be calculated using the formula below:

$$P = A + G + Y$$

- This value, which shall comply with the limit given in clauses 4.3.1.2.3 or clause 4.3.2.2.3, shall be recorded in the test report.

Test Data**Environmental Conditions**

Temperature:	24.1 °C
Relative Humidity:	51 %
ATM Pressure:	101.2kPa

The testing was performed by Ada Yu on 2017-07-06.

Test Mode: Transmitting

802.11b Mode

Test Condition			AV Output Power (dBm)	Antenna Gain (dBi)	EIRP (dBm)	Limits (dBm)	Test Results
Channel	Temperature (°C)	Voltage (V _{DC})					
Low	-25	12	14.61	3.0	17.61	20	Compliant
	+30		14.50	3.0	17.50	20	Compliant
	+85		14.43	3.0	17.43	20	Compliant
Middle	-25		13.78	3.0	16.78	20	Compliant
	+30		13.70	3.0	16.70	20	Compliant
	+85		13.63	3.0	16.63	20	Compliant
High	-25		14.08	3.0	17.08	20	Compliant
	+30		14.00	3.0	17.00	20	Compliant
	+85		13.97	3.0	16.97	20	Compliant

802.11g Mode

Test Condition			AV Output Power (dBm)	Antenna Gain (dBi)	EIRP (dBm)	Limits (dBm)	Test Results
Channel	Temperature (°C)	Voltage (V _{DC})					
Low	-25	12	12.59	3.0	15.59	20	Compliant
	+30		12.50	3.0	15.50	20	Compliant
	+85		12.47	3.0	15.47	20	Compliant
Middle	-25		12.48	3.0	15.48	20	Compliant
	+30		12.40	3.0	15.40	20	Compliant
	+85		12.34	3.0	15.34	20	Compliant
High	-25		12.60	3.0	15.60	20	Compliant
	+30		12.50	3.0	15.50	20	Compliant
	+85		12.40	3.0	15.40	20	Compliant

802.11n-HT20 Mode

Test Condition			AV Output Power (dBm)	Antenna Gain (dBi)	EIRP (dBm)	Limits (dBm)	Test Results
Channel	Temperature (°C)	Voltage (V _{DC})					
Low	-25	12	12.29	3.0	15.29	20	Compliant
	+30		12.20	3.0	15.20	20	Compliant
	+85		12.17	3.0	15.17	20	Compliant
Middle	-25		12.09	3.0	15.09	20	Compliant
	+30		12.00	3.0	15.00	20	Compliant
	+85		11.92	3.0	14.92	20	Compliant
High	-25		12.26	3.0	15.26	20	Compliant
	+30		12.20	3.0	15.20	20	Compliant
	+85		12.11	3.0	15.11	20	Compliant

802.11n-HT40 Mode

Test Condition			AV Output Power (dBm)	Antenna Gain (dBi)	EIRP (dBm)	Limits (dBm)	Test Results
Channel	Temperature (°C)	Voltage (V _{DC})					
Low	-25	12	12.05	3.0	15.05	20	Compliant
	+30		12.00	3.0	15.00	20	Compliant
	+85		11.90	3.0	14.90	20	Compliant
Middle	-25		11.74	3.0	14.74	20	Compliant
	+30		11.70	3.0	14.70	20	Compliant
	+85		11.61	3.0	14.61	20	Compliant
High	-25		11.83	3.0	14.83	20	Compliant
	+30		11.80	3.0	14.80	20	Compliant
	+85		11.72	3.0	14.72	20	Compliant

ETSI EN 300 328 V2.1.1 (2016-11) Clause 4.3.2.3 - POWER SPECTRAL DENSITY

Applicable Standard

According to ETSI EN 300 328 V2.1.1 (2016-11) Clause 4.3.2.3.1, this requirement applies to all types of equipment using wide band modulations other than FHSS.

The Power Spectral Density is the mean equivalent isotropically radiated power (e.i.r.p.) spectral density in a 1 MHz bandwidth during a transmission burst.

For equipment using wide band modulations other than FHSS, the maximum Power Spectral Density is limited to 10 dBm per MHz.

Test Procedure

Option 1: For equipment with continuous and non-continuous transmissions

The transmitter shall be connected to a spectrum analyser and the Power Spectral Density as defined in clause 4.3.2.3 shall be measured and recorded.

The test procedure shall be as follows:

Step 1:

Connect the UUT to the spectrum analyser and use the following settings:

- Start Frequency: 2 400 MHz
- Stop Frequency: 2 483.5 MHz
- Resolution BW: 10 kHz
- Video BW: 30 kHz
- Sweep Points: > 8 350

NOTE: For spectrum analysers not supporting this number of sweep points, the frequency band may be segmented.

- Detector: RMS
- Trace Mode: Max Hold
- Sweep time: For non-continuous transmissions: $2 \times \text{Channel Occupancy Time} \times \text{number of Sweeppoints}$
For continuous transmissions: 10 s; the sweep time may be increased further until a value where the sweep time has no further impact anymore on the RMS value of the signal.

NOTE: For non-continuous signals, wait for the trace to stabilize.

Save the data (trace data) set to a file.

Step 2:

For conducted measurements on smart antenna systems using either operating mode 2 or operating mode 3 (see clause 5.3.2.2), repeat the measurement for each of the transmit ports. For each sampling point (frequency domain), add up the coincident power values (in mW) for the different transmit chains and use this as the new data set.

Step 3:

Add up the values for power for all the samples in the file using the formula below.

$$P_{Sum} = \frac{1}{k} \sum_{n=1}^k P_{sample}(n)$$

with 'k' being the total number of samples and 'n' the actual sample number

Step 4:

Normalize the individual values for power (in dBm) so that the sum is equal to the RF Output Power (e.i.r.p.) measured in clause 5.4.2 and save the corrected data. The following formulas can be used:

$$C_{Corr} = P_{Sum} - P_{e.i.r.p}$$

$$P_{Samplecorr}(n) = P_{Sample}(n) - C_{Corr}$$

with 'n' being the actual sample number

Step 5:

Starting from the first sample $P_{Samplecorr}(n)$ (lowest frequency), add up the power (in mW) of the following samples representing a 1 MHz segment and record the results for power and position (i.e. sample #1 to sample #100). This is the Power Spectral Density (e.i.r.p.) for the first 1 MHz segment which shall be recorded.

Step 6:

Shift the start point of the samples added up in step 5 by one sample and repeat the procedure in step 5 (i.e. sample #2 to sample #101).

Step 7:

Repeat step 6 until the end of the data set and record the Power Spectral Density values for each of the 1 MHz segments.

From all the recorded results, the highest value is the maximum Power Spectral Density for the UUT. This value, which shall comply with the limit given in clause 4.3.2.3.3, shall be recorded in the test report.

Option 2: For equipment with continuous transmission capability or for equipment operating (or with the capability to operate) with a constant duty cycle (e.g. Frame Based equipment)

This option is for equipment that can be configured to operate in a continuous transmit mode (100 % DC) or with a constant Duty Cycle (DC).

Step 1:

Connect the UUT to the spectrum analyser and use the following settings:

- Centre Frequency: The centre frequency of the channel under test
- RBW: 1 MHz
- VBW: 3 MHz
- Frequency Span: $2 \times$ Nominal Bandwidth (e.g. 40 MHz for a 20 MHz channel)
- Detector Mode: Peak
- Trace Mode: Max Hold

Step 2:

When the trace is complete, find the peak value of the power envelope and record the frequency.

Step 3:

Make the following changes to the settings of the spectrum analyser:

- Centre Frequency: Equal to the frequency recorded in step 2
- Frequency Span: 3 MHz
- RBW: 1 MHz
- VBW: 3 MHz
- Sweep Time: 1 minute
- Detector Mode: RMS
- Trace Mode: Max Hold

Step 4:

When the trace is complete, the trace shall be captured using the "Hold" or "View" option on the spectrum analyser.

Find the peak value of the trace and place the analyser marker on this peak. This level is recorded as the highest mean power (power spectral density) D in a 1 MHz band.

Alternatively, where a spectrum analyser is equipped with a function to measure power spectral density, this function may be used to display the power spectral density D in dBm / MHz.

In case of conducted measurements on smart antenna systems operating in a mode with multiple transmit chains active simultaneously, the power spectral density of each transmit chain shall be measured separately to calculate the total power spectral density (value D in dBm / MHz) for the UUT.

Step 5:

The maximum Power Spectral Density (PSD) e.i.r.p. is calculated from the above measured power spectral density D , the observed Duty Cycle (DC) (see clause 5.4.2.2.1.3, step 4), the applicable antenna assembly gain G in dBi and if applicable the beamforming gain Y in dB, according to the formula below. This value shall be recorded in the test report. If more than one antenna assembly is intended for this power setting, the gain of the antenna assembly with the highest gain shall be used.

$$\text{PSD} = D + G + Y + 10 \times \log (1 / \text{DC}) \text{ (dBm / MHz)}$$

Test Setup Block diagram

802.11b/g/n

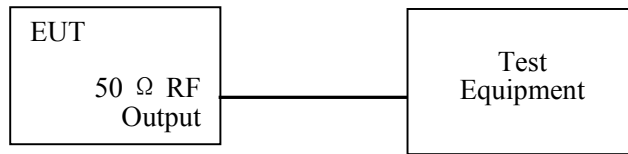

Test Data

Environmental Conditions

Temperature:	24.2 °C
Relative Humidity:	51 %
ATM Pressure:	101.2kPa

The testing was performed by Ada Yu on 2017-07-06.

Test Mode: Transmitting

Test Result: Compliant.

Frequency (MHz)	Level (dBm/MHz)	Limit (dBm/MHz)	Result
802.11b			
2412	7.67	<= 10.0	PASS
2442	6.89	<= 10.0	PASS
2472	7.22	<= 10.0	PASS
802.11g			
2412	3.82	<= 10.0	PASS
2442	3.67	<= 10.0	PASS
2472	3.79	<= 10.0	PASS
802.11n-HT20			
2412	3.37	<= 10.0	PASS
2442	3.02	<= 10.0	PASS
2472	3.32	<= 10.0	PASS
802.11n-HT40			
2422	0.23	<= 10.0	PASS
2442	-0.33	<= 10.0	PASS
2462	-0.20	<= 10.0	PASS

Please refer to following table and plots.

802.11b Mode, Low Channel: 2412 MHz

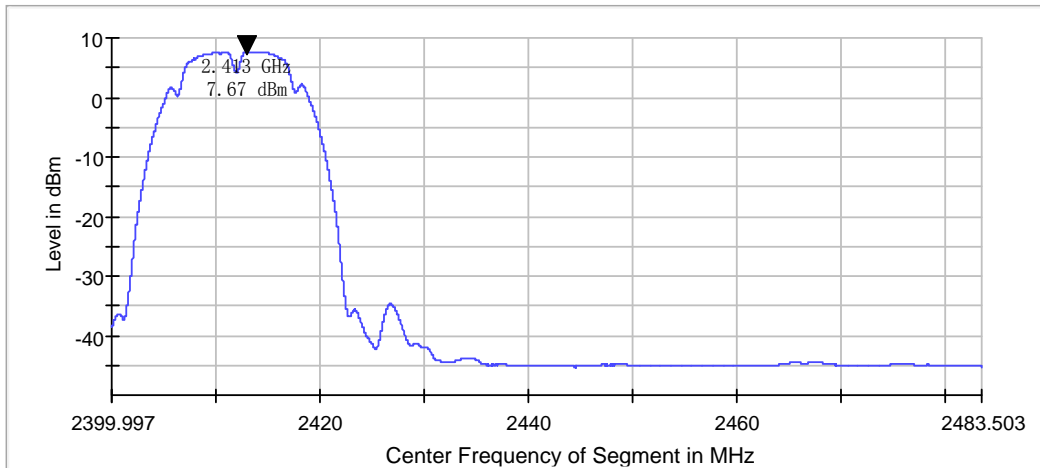

802.11b Mode, Middle Channel: 2442 MHz

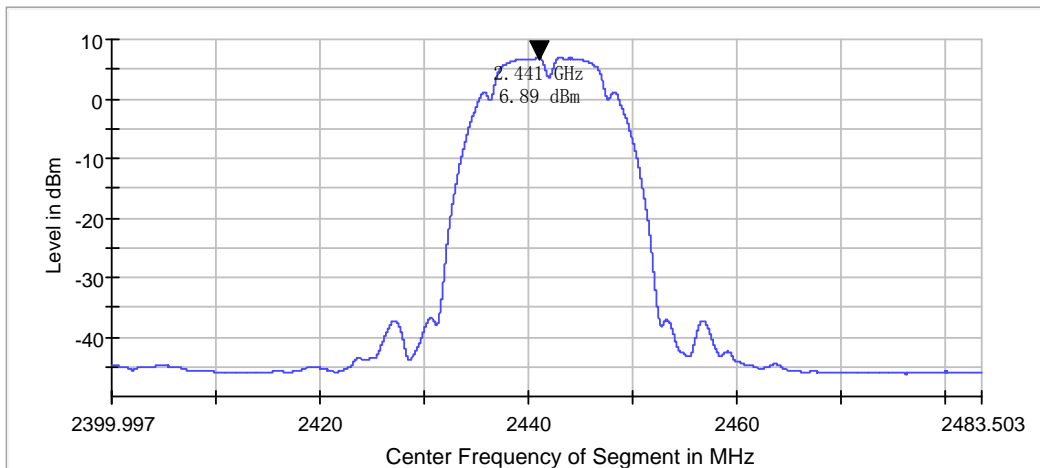

802.11b Mode, High Channel: 2472 MHz

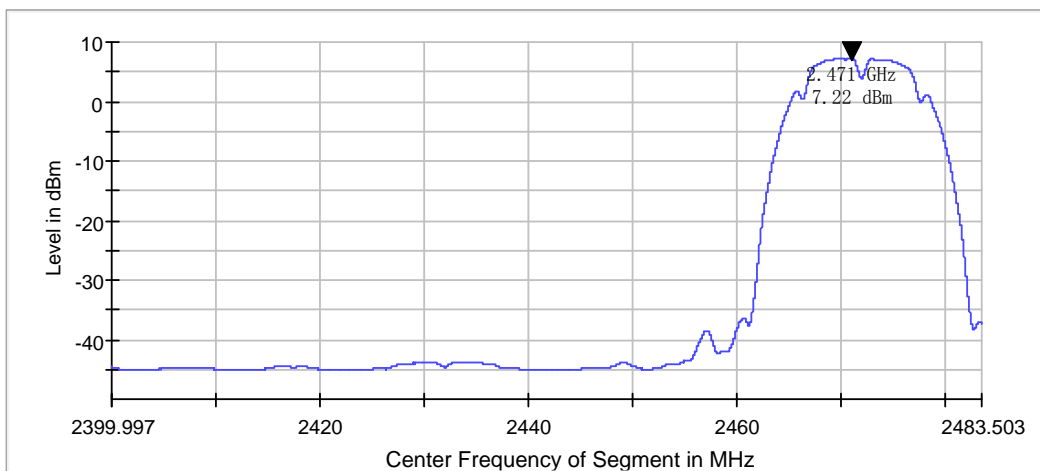

802.11g Mode, Low Channel: 2412 MHz

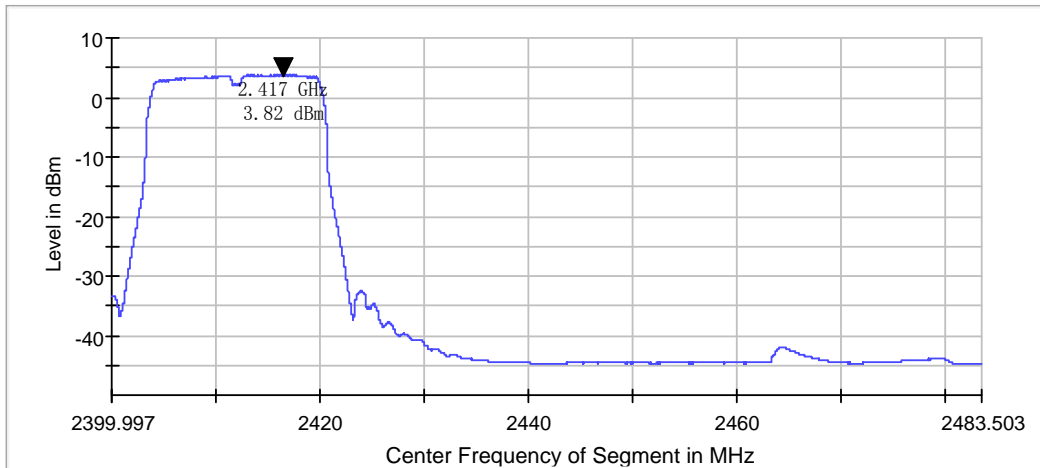

802.11g Mode, Middle Channel: 2442 MHz

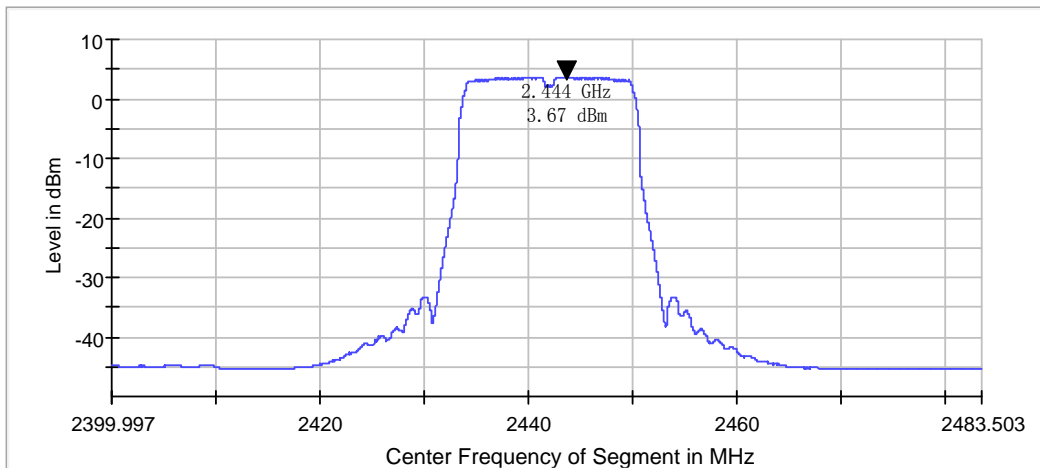

802.11g Mode, High Channel: 2472 MHz

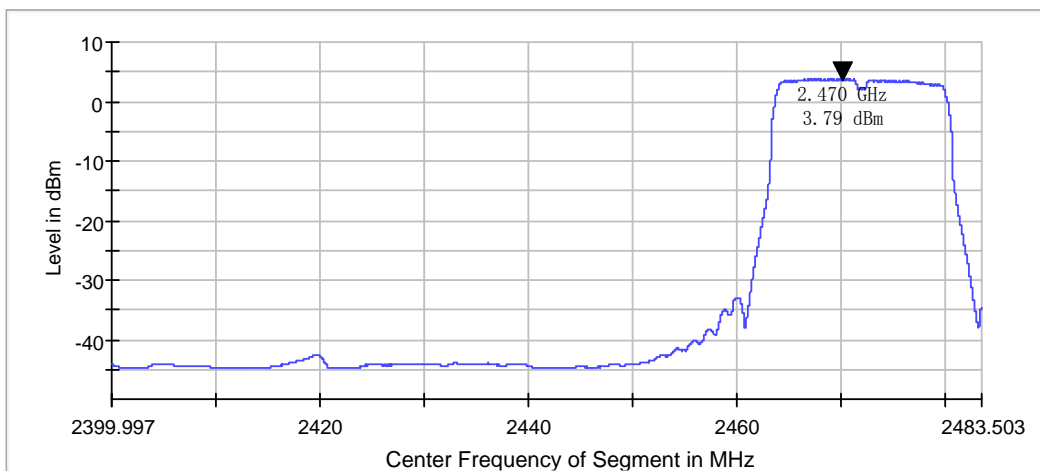

802.11n-HT20 Mode, Low Channel: 2412 MHz

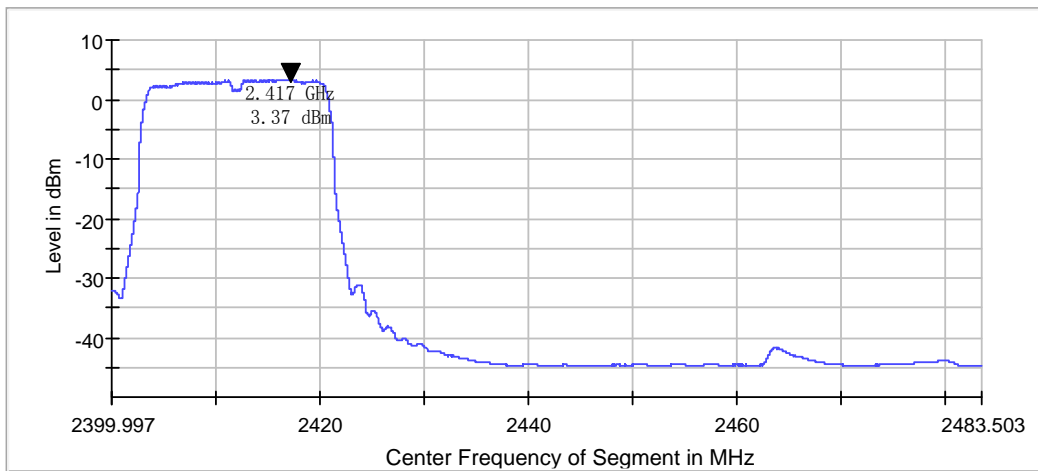

802.11n-HT20 Mode, Middle Channel: 2442 MHz

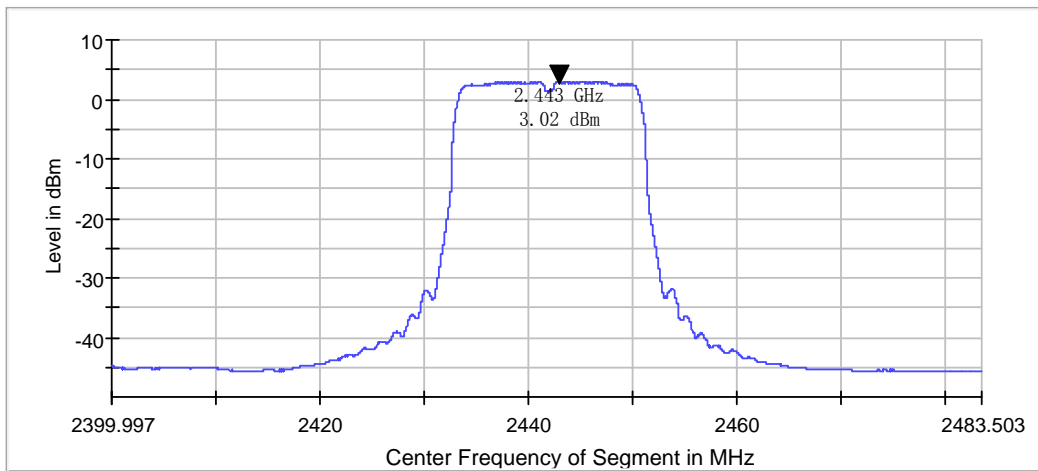

802.11n-HT20 Mode, High Channel: 2472 MHz

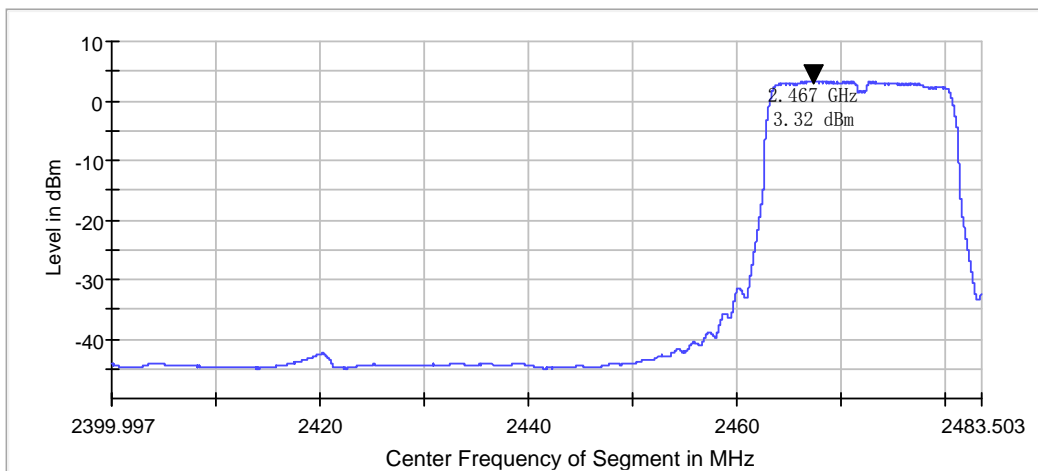

802.11n-HT40 Mode, Low Channel: 2422 MHz

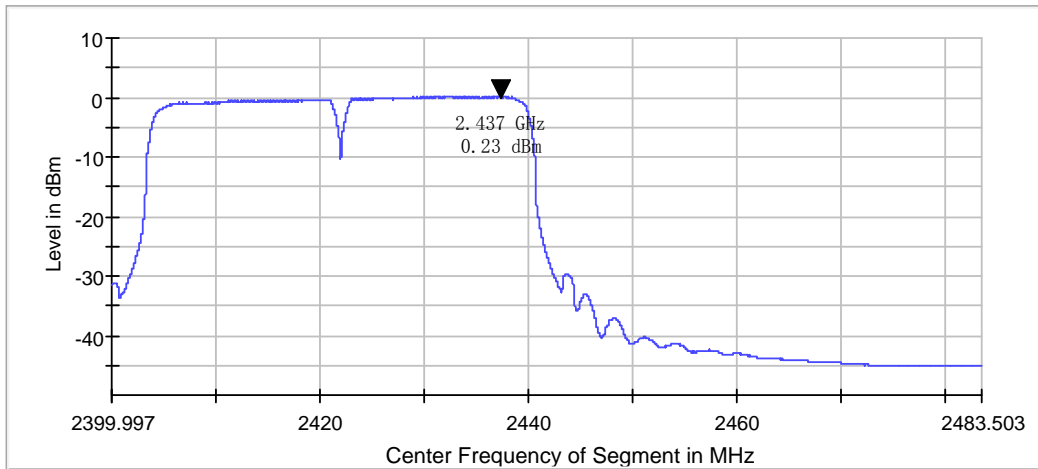

802.11n-HT40 Mode, Middle Channel: 2442 MHz

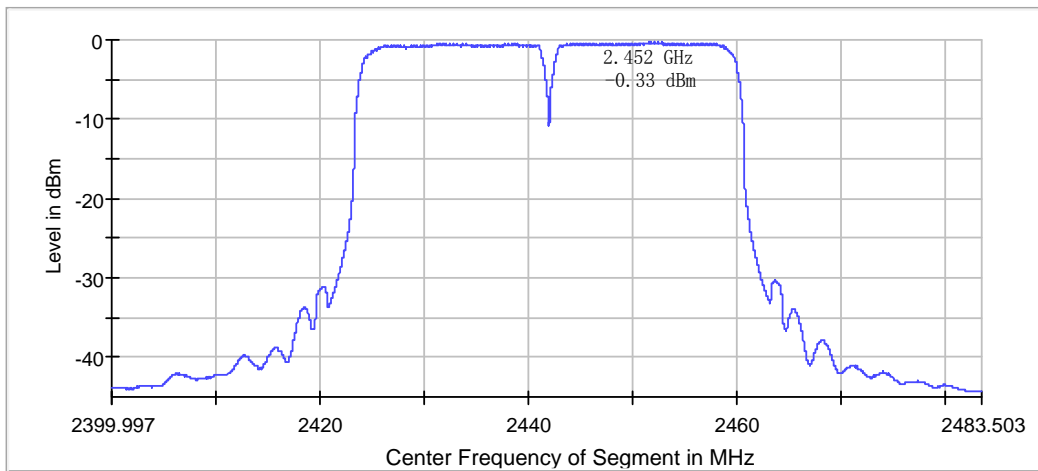

802.11n-HT40 Mode, High Channel: 2462 MHz

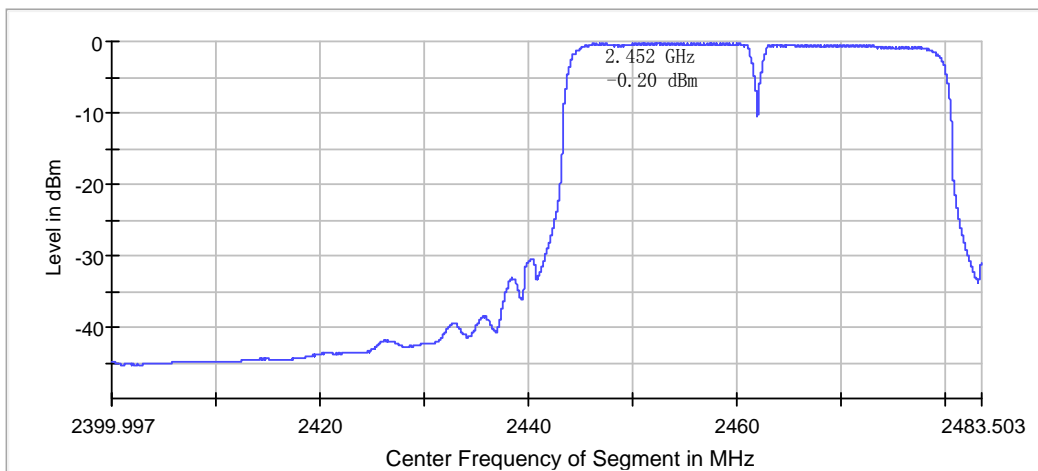

ETSI EN 300 328 V2.1.1 (2016-11) Clause 4.3.2.6 – ADAPTIVITY

Applicable Standard

Non-LBT based Detect and Avoid:

Non-LBT based Detect and Avoid is a mechanism for equipment using wide band modulations other than FHSS and by which a given channel is made 'unavailable' because an interfering signal was reported after the transmission in that channel. This mechanism shall operate as intended in the presence of an unwanted signal on frequencies other than those of the operating band.

LBT based Detect and Avoid:

LBT based Detect and Avoid is a mechanism by which equipment using wide band modulations other than FHSS, avoids transmissions in a channel in the presence of an interfering signal in that channel. This mechanism shall operate as intended in the presence of an unwanted signal on frequencies other than those of the operating band.

Limit:

According to ETSI EN 300 328 V2.1.1 (2016-11) Clause 4.3.2.6.2.2 & 4.3.2.6.3.2

Adaptive equipment using wide band modulations other than FHSS, shall comply with the requirements defined in clause 4.3.2.6.2 (non-LBT based DAA) or clause 4.3.2.6.3 (LBT based DAA).

Test Procedure

According to ETSI EN 300 328 V2.1.1 (2016-11) Clause 5.4.6.2

Test Setup Block diagram

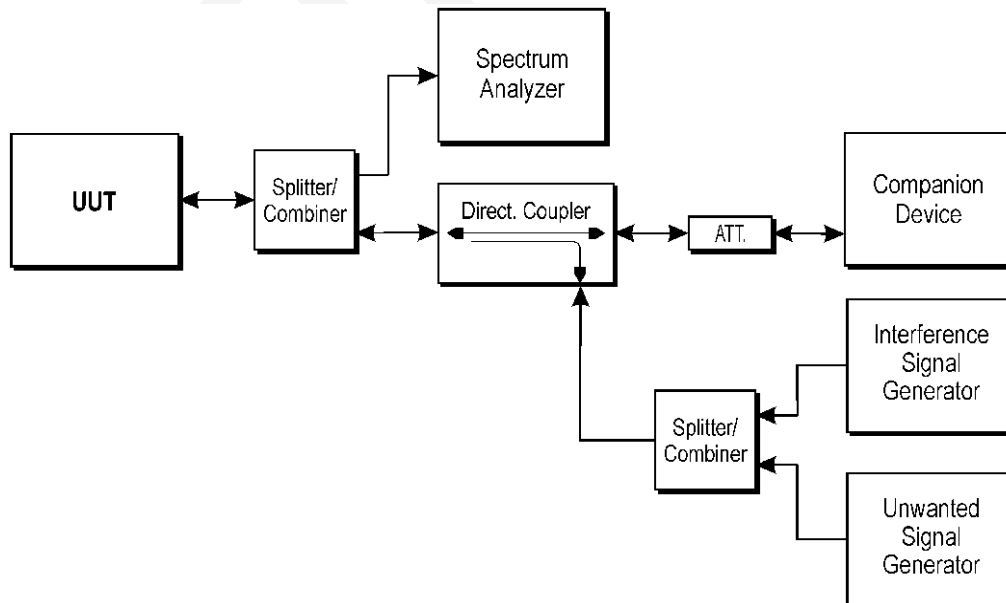

Figure 5: Test set-up for verifying the adaptivity of an equipment

Test data**Environmental Conditions**

Temperature:	24.2 °C
Relative Humidity:	51 %
ATM Pressure:	101.2kPa

The testing was performed by Ada Yu on 2017-07-06.

Test Mode: Transmitting in 802.11b mode.

Test Result: Compliant

Please refer to the following plots:

Frequency (MHz)	Test Step	No. of Bursts	Max Burst Power (dBm)	COT (ms)	Limit (ms)	Result
2412	Test Step 1	4	20.0	2.622	<13.000	PASS
2472	Test Step 1	2	20.0	1.722	<13.000	PASS

Frequency (MHz)	Test Step	No. of Bursts	Max Burst Power (dBm)	Short Signaling (%)	Limit (%)	Result
2412	Test Step 2	2	14.9	3.5	<10.0	PASS
2412	Test Step 2_2nd	2	14.9	3.5	<10.0	PASS
2472	Test Step 2	2	15.7	3.5	<10.0	PASS
2472	Test Step 2_2nd	2	15.7	3.5	<10.0	PASS

Adaptivity Test schematic graphic

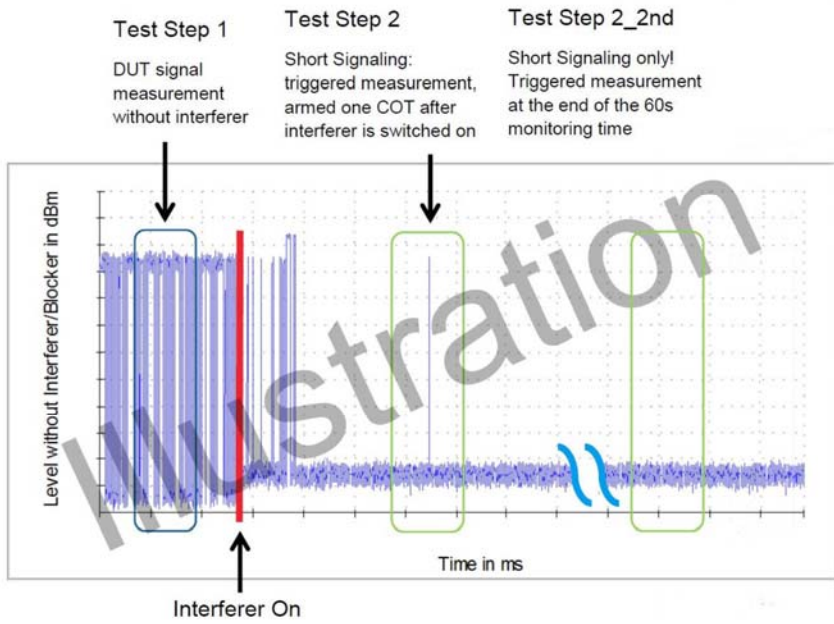

Note: There will be no transmitting when the blocker was turned on.

Low Channel Reaction to the interference signal

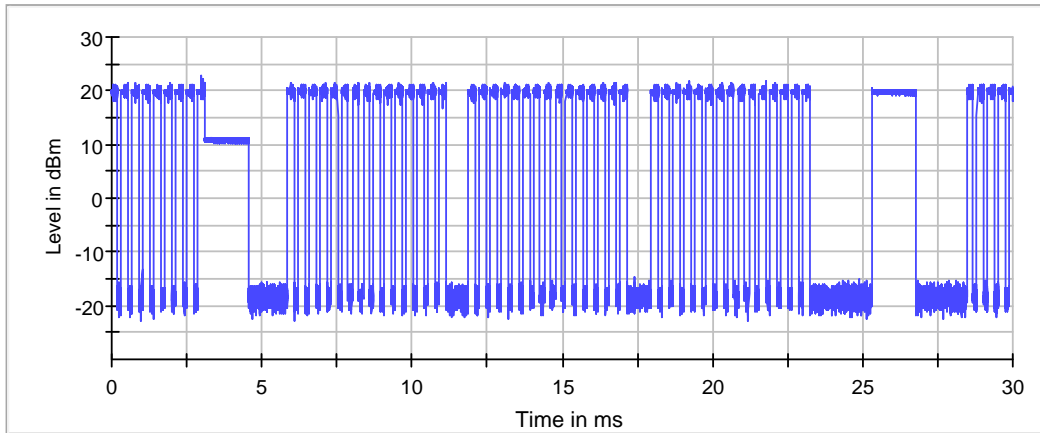

— Test Step 1

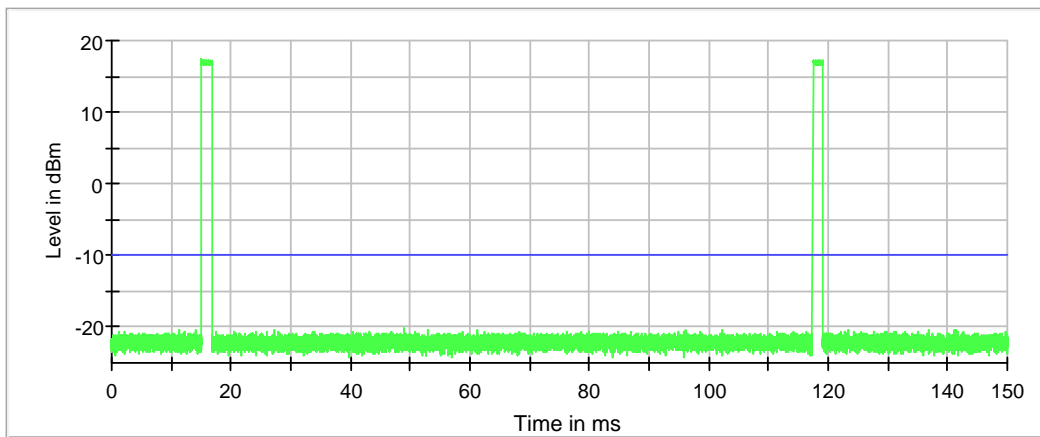

— Test Step 2 — Limit for Evaluation

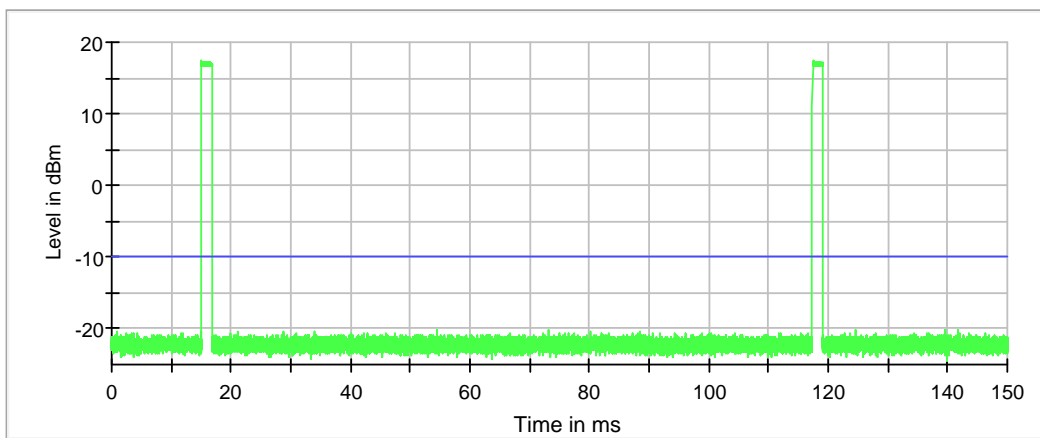

— Test Step 2_2 — Limit for Evaluation

High Channel Reaction to the interference signal

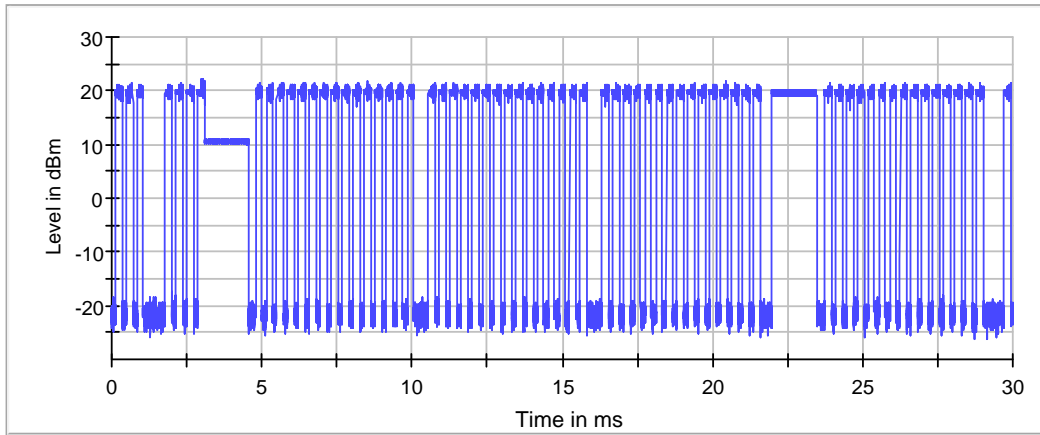

— Test Step 1

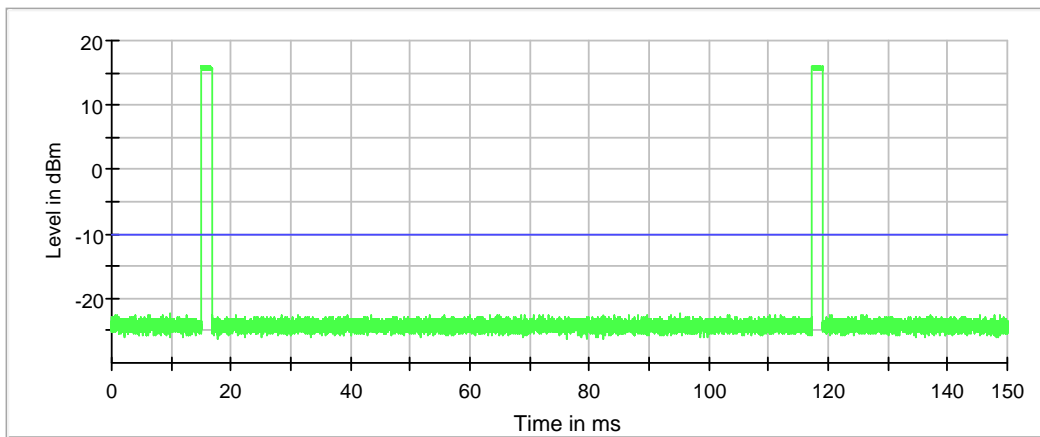

— Test Step 2 — Limit for Evaluation

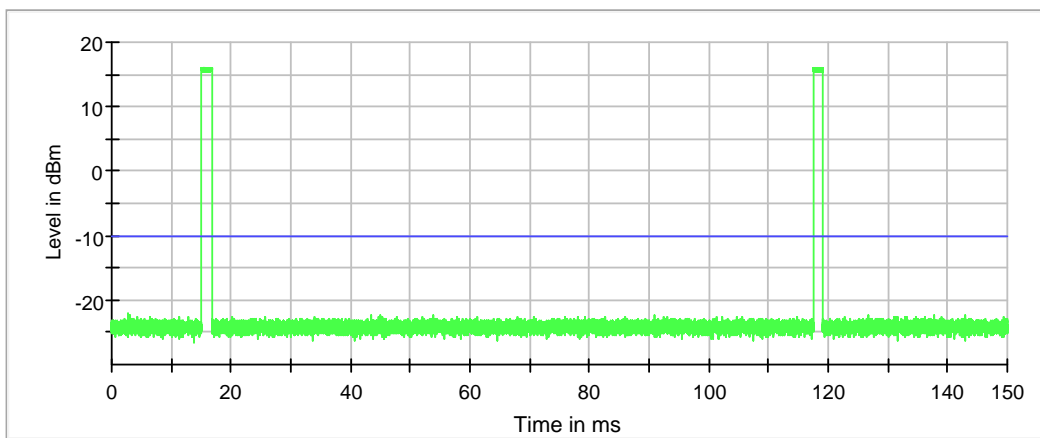

— Test Step 2_2 — Limit for Evaluation

ETSI EN 300 328 V2.1.1 (2016-11) Clause 4.3.2.7 – OCCUPIED CHANNEL BANDWIDTH

Applicable Standard

According to ETSI EN 300 328 V2.1.1 (2016-11) Clause 4.3.2.7.2, the occupied channel bandwidth is the bandwidth that contains 99 % of the power of the signal.

Limit:

The Occupied Channel Bandwidth shall fall completely within the band given in table 1. In addition, for non-adaptive equipment using wide band modulations other than FHSS and with e.i.r.p greater than 10 dBm, the occupied channel bandwidth shall be less than 20 MHz.

Test Procedure

The measurement procedure shall be as follows:

Step 1:

Connect the UUT to the spectrum analyser and use the following settings:

- Centre Frequency: The centre frequency of the channel under test
- Resolution BW: ~ 1 % of the span without going below 1 %
- Video BW: $3 \times$ RBW
- Frequency Span: $2 \times$ Nominal Channel Bandwidth
- Detector Mode: RMS
- Trace Mode: Max Hold
- Sweep time: 1 s

Step 2:

Wait for the trace to stabilize.
Find the peak value of the trace and place the analyser marker on this peak.

Step 3:

Use the 99 % bandwidth function of the spectrum analyser to measure the Occupied Channel Bandwidth of the UUT. This value shall be recorded.

NOTE: Make sure that the power envelope is sufficiently above the noise floor of the analyser to avoid the noise signals left and right from the power envelope being taken into account by this measurement.

Test Data**Environmental Conditions**

Temperature:	24.1 °C
Relative Humidity:	51 %
ATM Pressure:	101.2kPa

The testing was performed by Ada Yu on 2017-07-06.

Test Mode: Transmitting

Channel	Frequency (MHz)	Occupied Bandwidth (MHz)
802.11b		
Low	2412	15.23
High	2472	15.20
802.11g		
Low	2412	18.07
High	2472	18.07
802.11n-HT20		
Low	2412	18.30
High	2472	18.33
802.11n-HT40		
Low	2422	36.51
High	2462	36.49

802.11b, Low Channel

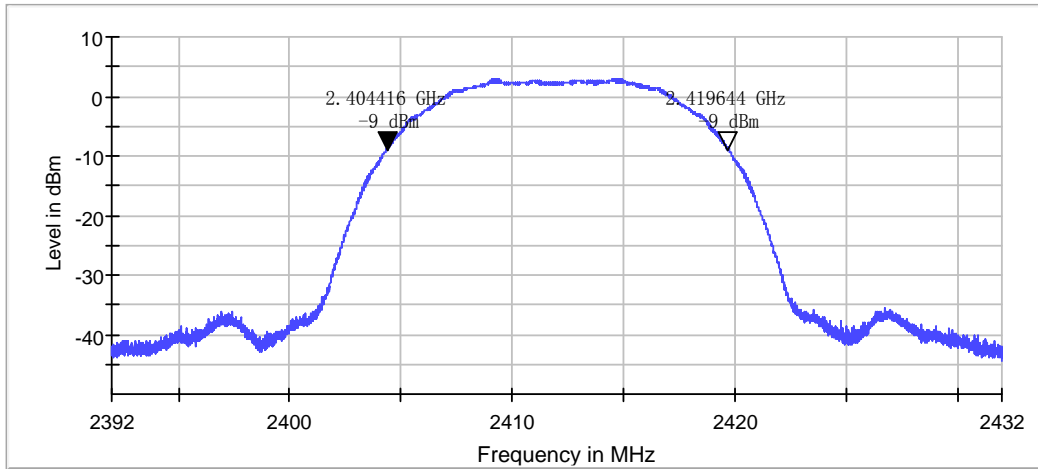

802.11b, High Channel

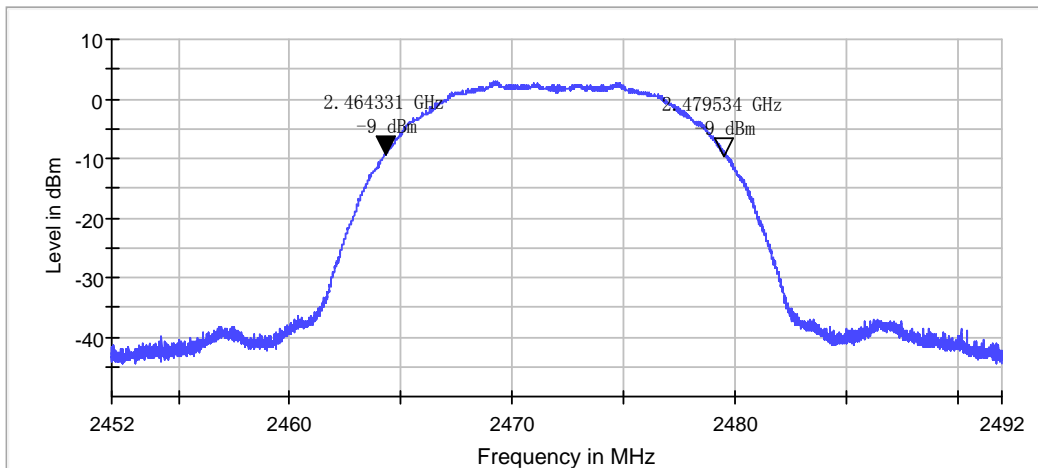

802.11g, Low Channel

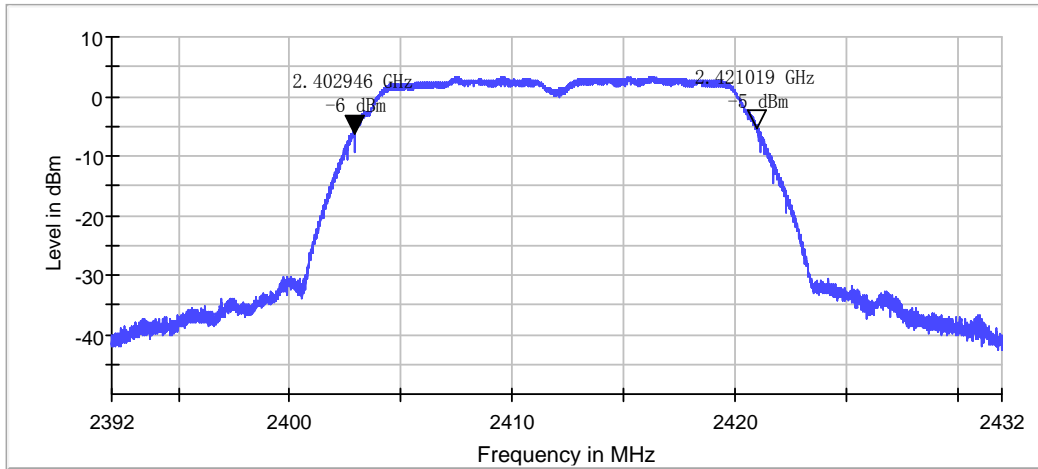

802.11g, High Channel

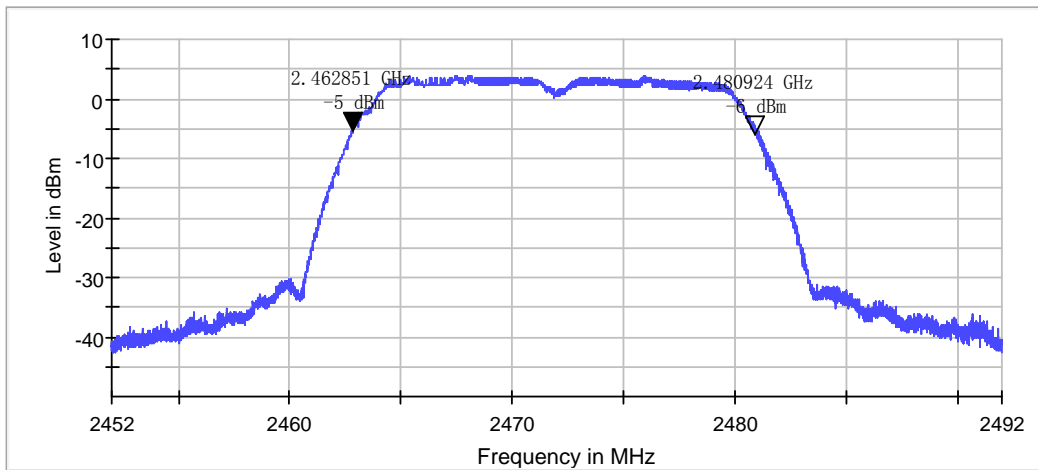

802.11n-HT20, Low Channel

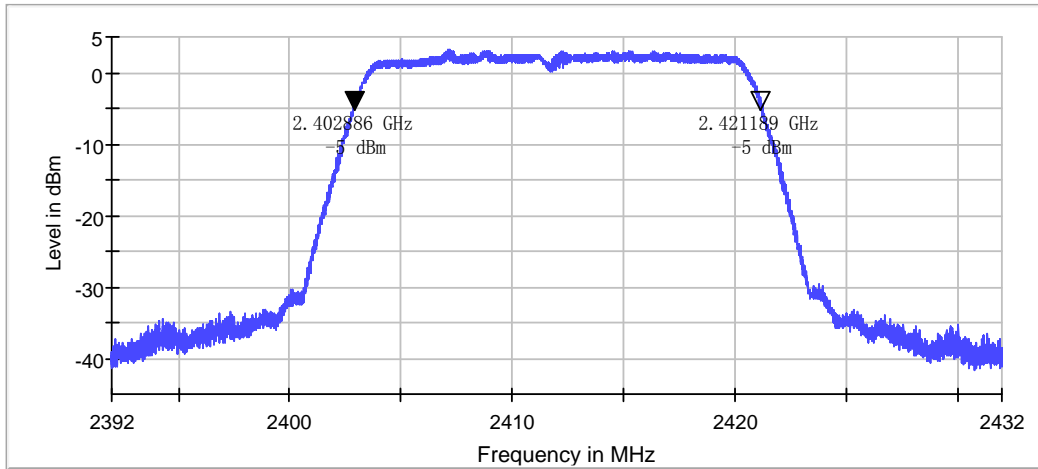

802.11n-HT20, High Channel

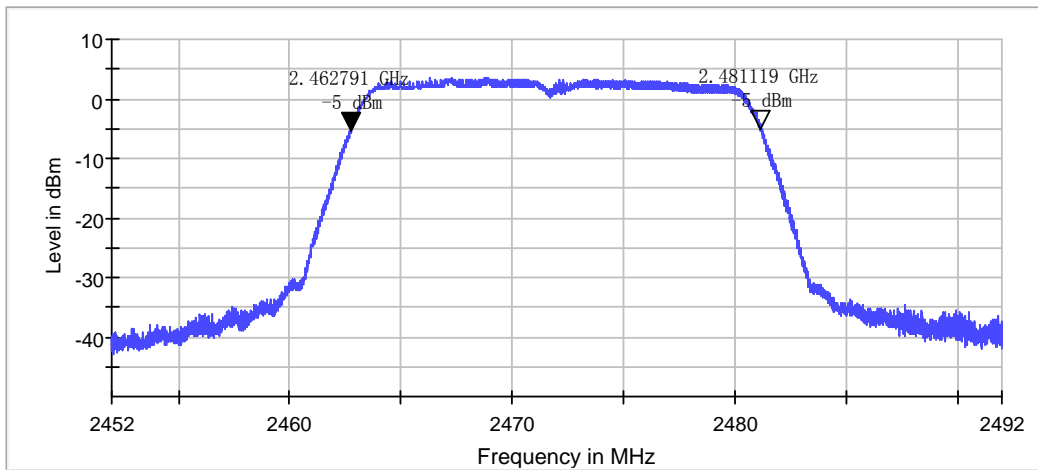

802.11n-HT40, Low Channel

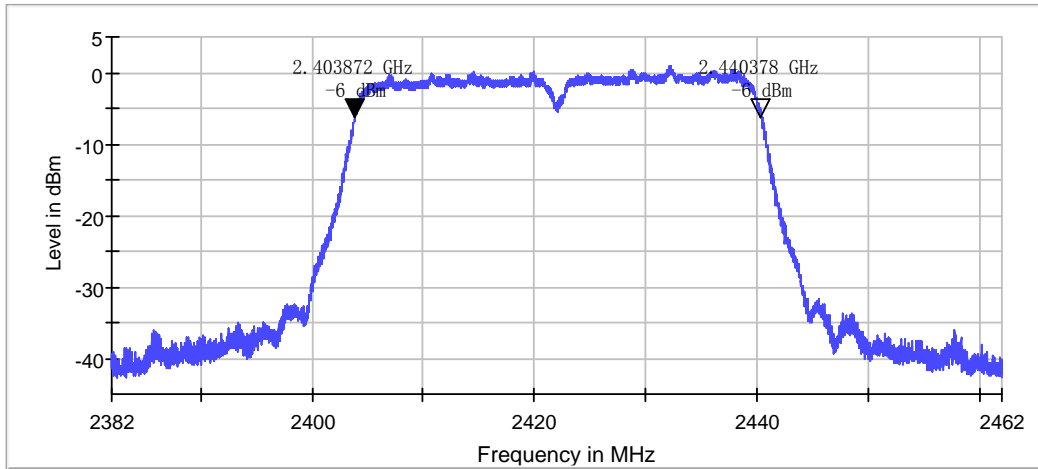

802.11n-HT40, High Channel

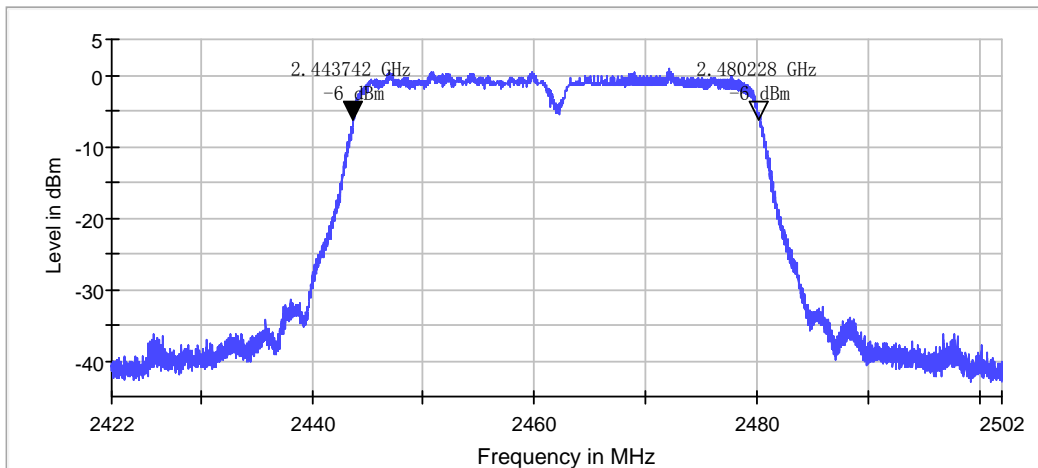

ETSI EN 300 328 V2.1.1 (2016-11) Clause 4.3.2.8 – TRANSMITTER UNWANTED EMISSION IN THE OUT-OF-BAND DOMAIN

Applicable Standard

According to ETSI EN 300 328 V2.1.1 (2016-11) Clause 4.3.2.8.2, Transmitter unwanted emissions in the out-of-band domain are emissions when the equipment is in Transmit mode, on frequencies immediately outside the necessary bandwidth which results from the modulation process, but excluding spurious emissions.

Limit:

The transmitter unwanted emissions in the out-of-band domain but outside the allocated band, shall not exceed the values provided by the mask in figure 3.

Within the band specified in table 1, the Out-of-band emissions are fulfilled by compliance with the Occupied Channel Bandwidth requirement in clause 4.3.2.7.

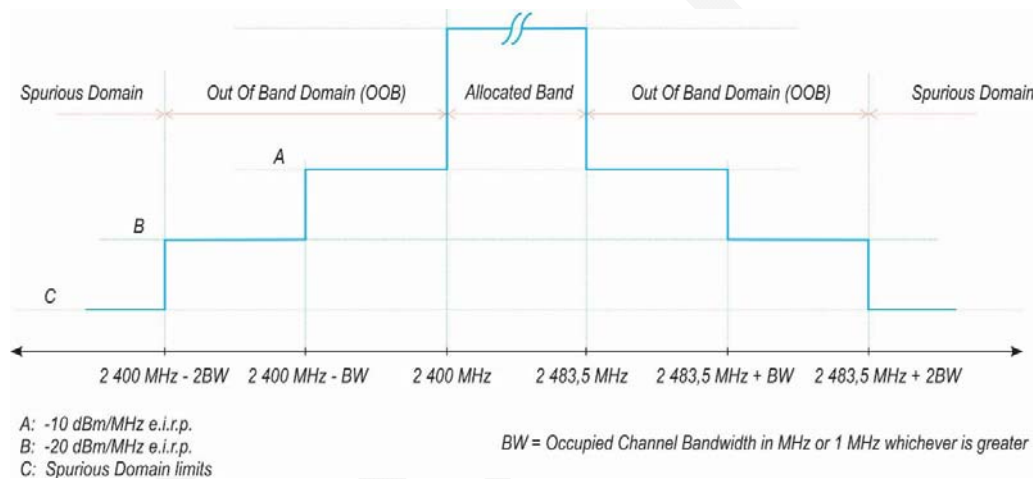

Figure 3: Transmit mask

Test Procedure

The measurement procedure shall be as follows:

Step 1:

- Connect the UUT to the spectrum analyser and use the following settings:
 - Centre Frequency: 2 484 MHz
 - Span: 0 Hz
 - Resolution BW: 1 MHz
 - Filter mode: Channel filter
 - Video BW: 3 MHz
 - Detector Mode: RMS
 - Trace Mode: Max Hold
 - Sweep Mode: Continuous
 - Sweep Points: Sweep Time [s] / (1 μ s) or 5 000 whichever is greater
 - Trigger Mode: Video trigger; in case video triggering is not possible, an external trigger source may be used

- Sweep Time: > 120 % of the duration of the longest burst detected during the measurement of the RF Output Power

Step 2 (segment 2 483,5 MHz to 2 483,5 MHz + BW):

- Adjust the trigger level to select the transmissions with the highest power level.
- For frequency hopping equipment operating in a normal hopping mode, the different hops will result in signal bursts with different power levels. In this case the burst with the highest power level shall be selected.
- Set a window (start and stop lines) to match with the start and end of the burst and in which the RMS power shall be measured using the Time Domain Power function.
- Select RMS power to be measured within the selected window and note the result which is the RMS power within this 1 MHz segment (2 483,5 MHz to 2 484,5 MHz). Compare this value with the applicable limit provided by the mask.
- Increase the centre frequency in steps of 1 MHz and repeat this measurement for every 1 MHz segment within the range 2 483,5 MHz to 2 483,5 MHz + BW. The centre frequency of the last 1 MHz segment shall be set to 2 483,5 MHz + BW - 0,5 MHz (which means this may partly overlap with the previous 1 MHz segment).

Step 3 (segment 2 483,5 MHz + BW to 2 483,5 MHz + 2BW):

- Change the centre frequency of the analyser to 2 484 MHz + BW and perform the measurement for the first 1 MHz segment within range 2 483,5 MHz + BW to 2 483,5 MHz + 2BW. Increase the centre frequency in 1 MHz steps and repeat the measurements to cover this whole range. The centre frequency of the last 1 MHz segment shall be set to 2 483,5 MHz + 2 BW - 0,5 MHz (which means this may partly overlap with the previous 1 MHz segment).

Step 4 (segment 2 400 MHz - BW to 2 400 MHz):

- Change the centre frequency of the analyser to 2 399,5 MHz and perform the measurement for the first 1 MHz segment within range 2 400 MHz - BW to 2 400 MHz. Reduce the centre frequency in 1 MHz steps and repeat the measurements to cover this whole range. The centre frequency of the last 1 MHz segment shall be set to 2 400 MHz - BW + 0,5 MHz (which means this may partly overlap with the previous 1 MHz segment).

Step 5 (segment 2 400 MHz - 2BW to 2 400 MHz - BW):

- Change the centre frequency of the analyser to 2 399,5 MHz - BW and perform the measurement for the first 1 MHz segment within range 2 400 MHz - 2BW to 2 400 MHz - BW. Reduce the centre frequency in 1 MHz steps and repeat the measurements to cover this whole range. The centre frequency of the last 1 MHz segment shall be set to 2 400 MHz - 2BW + 0,5 MHz (which means this may partly overlap with the previous 1 MHz segment).

Step 6:

- In case of conducted measurements on equipment with a single transmit chain, the declared antenna assembly gain G in dBi shall be added to the results for each of the 1 MHz segments and compared with the limits provided by the mask given in figure 1 or figure 3. If more than one antenna assembly is intended for this power setting, the antenna with the highest gain shall be considered.

- In case of conducted measurements on smart antenna systems (equipment with multiple transmit chains), the measurements need to be repeated for each of the active transmit chains. The declared antenna assembly gain G in dBi for a single antenna shall be added to these results. If more than one antenna assembly is intended for this power setting, the antenna with the highest gain shall be considered. Comparison with the applicable limits shall be done using any of the options given below:
 - Option 1: the results for each of the transmit chains for the corresponding 1 MHz segments shall be added. The additional beamforming gain Y in dB shall be added as well and the resulting values compared with the limits provided by the mask given in figure 1 or figure 3.
 - Option 2: the limits provided by the mask given in figure 1 or figure 3 shall be reduced by $10 \times \log_{10}(A_{ch})$ and the additional beamforming gain Y in dB. The results for each of the transmit chains shall be individually compared with these reduced limits.

NOTE: A_{ch} refers to the number of active transmit chains.

It shall be recorded whether the equipment complies with the mask provided in figure 1 or figure 3.

Test Data

Environmental Conditions

Temperature:	24.2 °C
Relative Humidity:	51 %
ATM Pressure:	101.2Pa

The testing was performed by Ada Yu on 2017-07-06.

Test Mode: Transmitting

Test Result: Compliant, please refer to following plots.

802.11b- Low Frequency

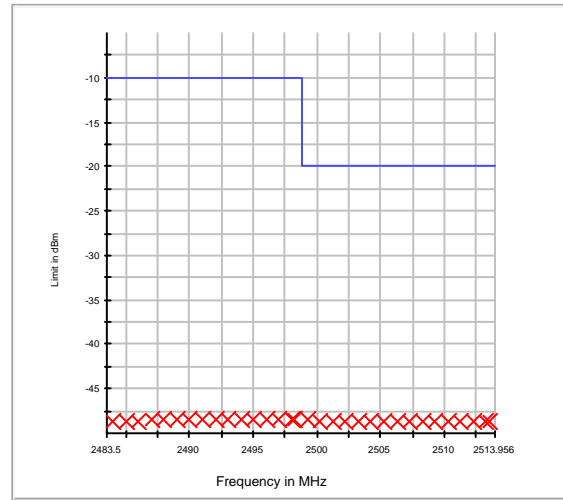
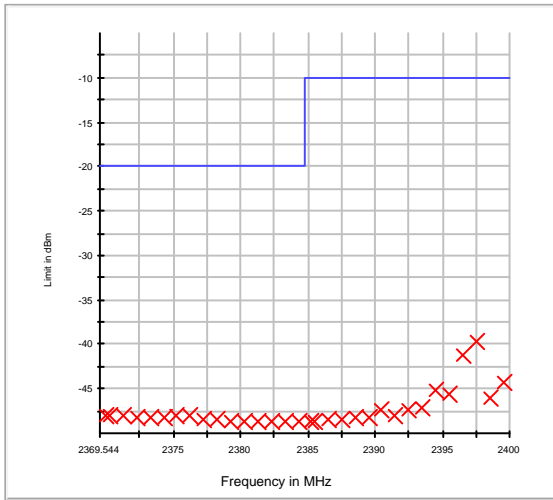

802.11b-High Frequency

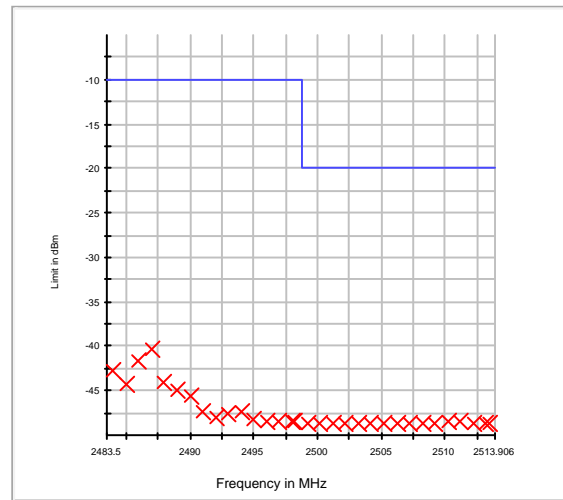
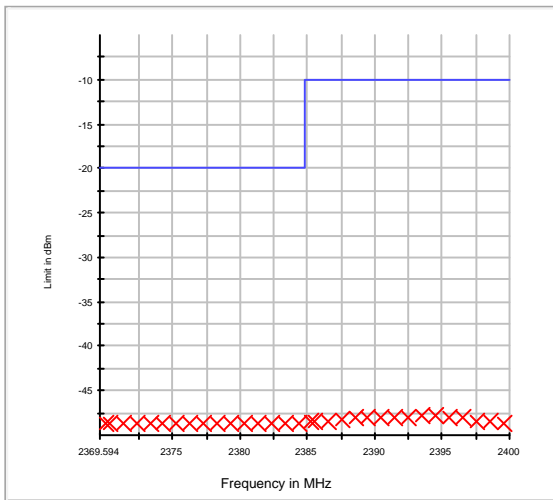

802.11g- Low Frequency

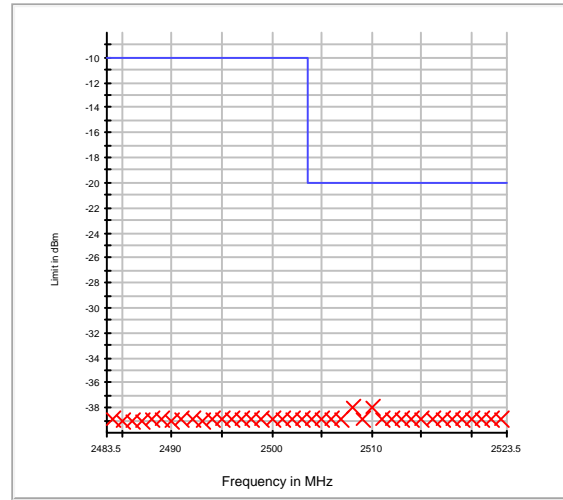
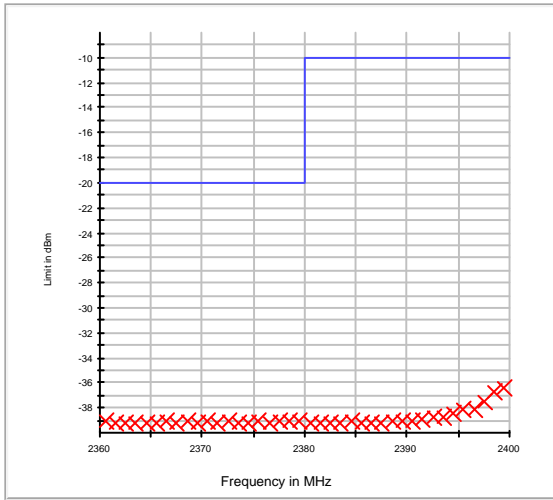

802.11g- High Frequency

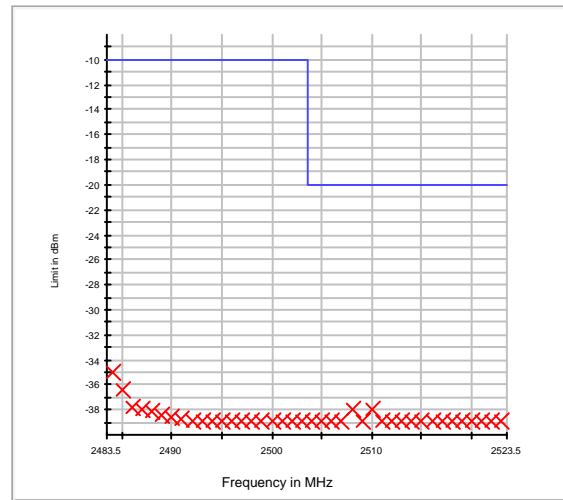
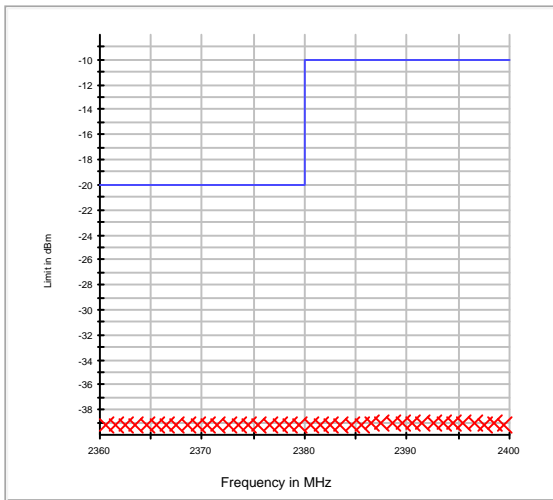

802.11n20- Low Frequency

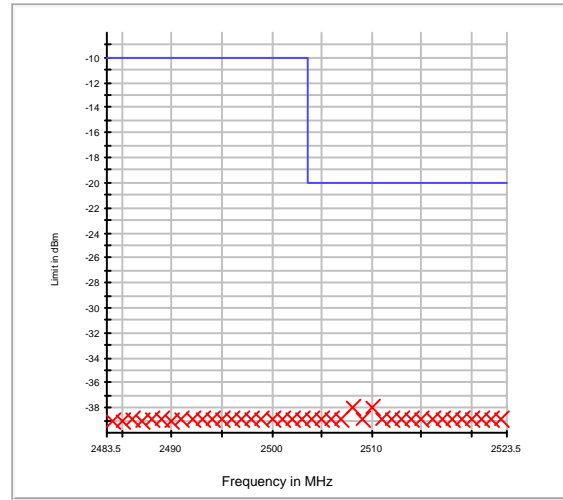
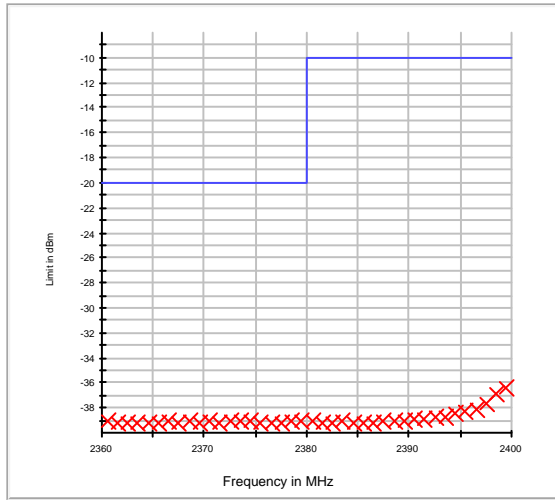

802.11n20- High Frequency

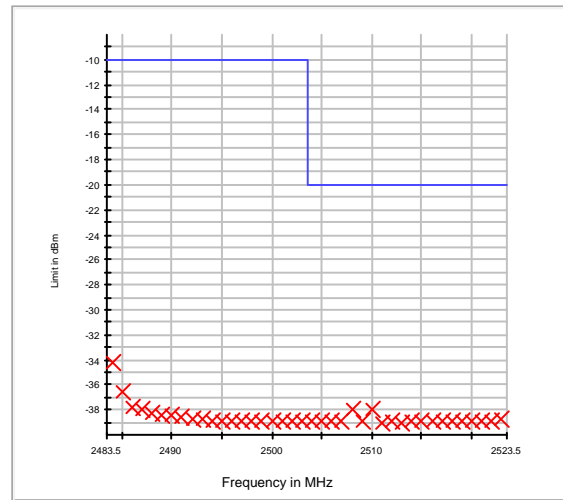
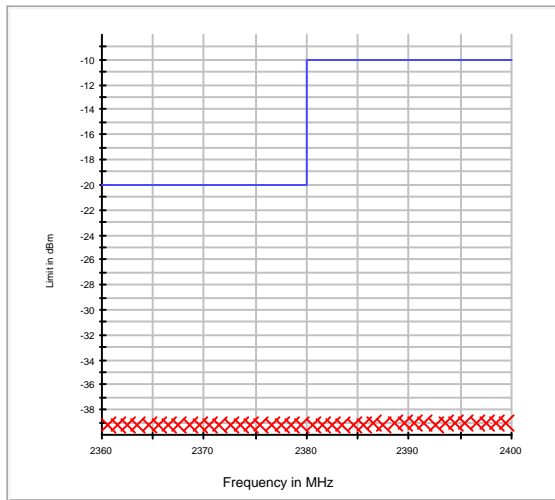

802.11n40- Low Frequency

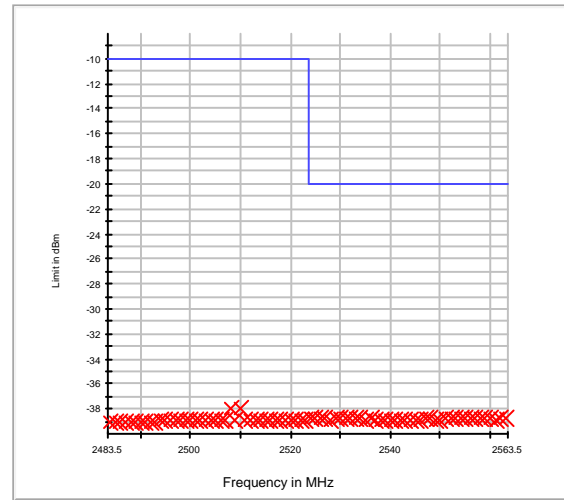
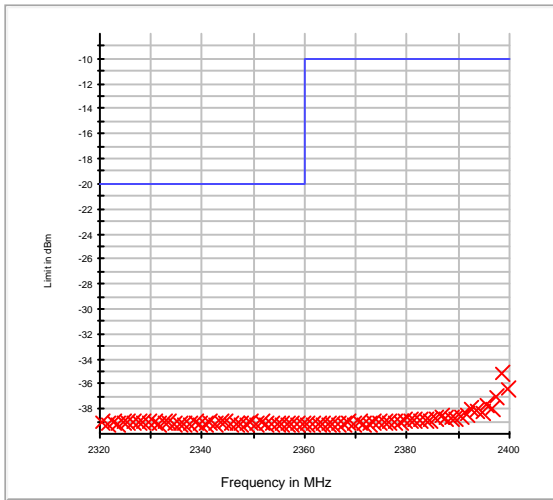

802.11n40- High Frequency

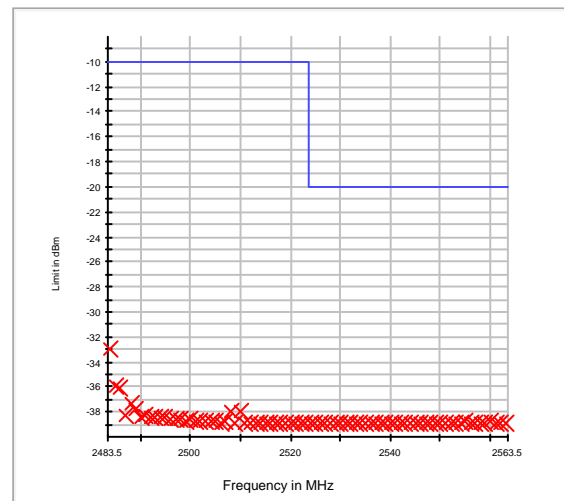
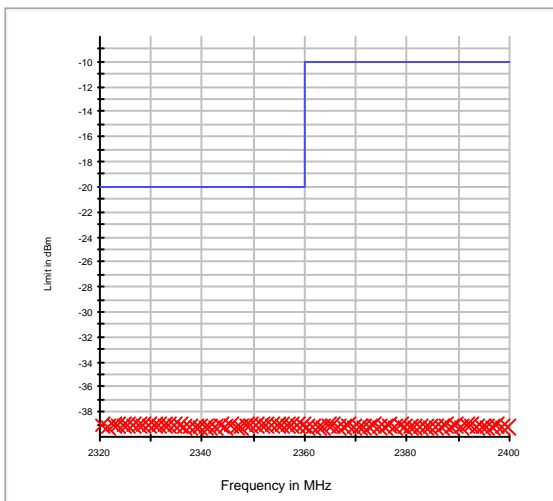

ETSI EN 300 328 V2.1.1 (2016-11) Clause 4.3.2.9 – TRANSMITTER UNWANTED EMISSION IN THE SPURIOUS DOMAIN

Applicable Standard

Transmitter unwanted emissions in the spurious domain are emissions outside the allocated band and outside the Out-of-band Domain as indicated in figure 3 when the equipment is in Transmit mode.

The transmitter unwanted emissions in the spurious domain shall not exceed the values given in the following table.

Transmitter limits for spurious emissions

Frequency Range	Maximum power e.r.p (≤ 1 GHz) e.i.r.p (> 1 GHz)	Bandwidth
30 MHz to 47 MHz	-36 dBm	100 kHz
47 MHz to 74 MHz	-54 dBm	100 kHz
74 MHz to 87,5 MHz	-36 dBm	100 kHz
87,5 MHz to 118 MHz	-54 dBm	100 kHz
118 MHz to 174 MHz	-36 dBm	100 kHz
174 MHz to 230 MHz	-54 dBm	100 kHz
230 MHz to 470 MHz	-36 dBm	100 kHz
470 MHz to 862 MHz	-54 dBm	100 kHz
862 MHz to 1 GHz	-36 dBm	100 kHz
1 GHz to 12,75 GHz	-30 dBm	1 MHz

NOTE: In case of equipment with antenna connectors, these limits apply to emissions at the antenna port (conducted). For emissions radiated by the cabinet or emissions radiated by integral antenna equipment (without antenna connectors), these limits are e.r.p. for emissions up to 1 GHz and as e.i.r.p. for emissions above 1 GHz.

Test Procedure

Pre-scan:

The procedure in step 1 to step 4 below shall be used to identify potential unwanted emissions of the UUT.

Step 1:

The sensitivity of the spectrum analyser should be such that the noise floor is at least 12 dB below the limits given in table 5 or table 13.

Step 2:

The emissions over the range 30 MHz to 1 000 MHz shall be identified.

Spectrum analyser settings:

- Resolution bandwidth: 100 kHz
- Video bandwidth: 300 kHz

- Filter type: 3 dB (Gaussian)
- Detector mode: Peak
- Trace Mode: Max Hold
- Sweep Points: $\geq 19\,400$
- Sweep time: Auto

Wait for the trace to stabilize. Any emissions identified during the sweeps above and that fall within the 6 dB range below the applicable limit or above, shall be individually measured using the procedure in clause 5.4.10.2.1.3 and compared to the limits given in table 5 or table 13.

Step 3:

The emissions over the range 1 GHz to 12,75 GHz shall be identified.

Spectrum analyser settings:

- Resolution bandwidth: 1 MHz
- Video bandwidth: 3 MHz
- Filter type: 3 dB (Gaussian)
- Detector mode: Peak
- Trace Mode: Max Hold
- Sweep Points: $\geq 23\,500$; for spectrum analysers not supporting this high number of sweep points, the frequency band may be segmented
- Sweep time: Auto

Wait for the trace to stabilize. Any emissions identified during the sweeps above that fall within the 6 dB range below the applicable limit or above, shall be individually measured using the procedure in clause 5.4.10.2.1.3 and compared to the limits given in table 5 or table 13.

Frequency Hopping equipment may generate a block (or several blocks) of spurious emissions anywhere within the spurious domain. If this is the case, only the highest peak of each block of emissions shall be measured using the procedure in clause 5.4.10.2.1.3.

Step 4:

- In case of conducted measurements on smart antenna systems (equipment with multiple receive chains), step 2 and step 3 need to be repeated for each of the active receive chains. The limits used to identify emissions during this pre-scan need to be reduced by $10 \times \log_{10} A_{ch}$.

Measurement of the emissions identified during the pre-scan:

The procedure in step 1 to step 4 below shall be used to accurately measure the individual unwanted emissions identified during the pre-scan measurements above. This method assumes the spectrum analyser has a Time Domain Power function.

Step 1:

The level of the emissions shall be measured using the following spectrum analyser settings:

- Measurement Mode: Time Domain Power
- Centre Frequency: Frequency of the emission identified during the pre-scan
- Resolution Bandwidth: 100 kHz (< 1 GHz) / 1 MHz (> 1 GHz)
- Video Bandwidth: 300 kHz (< 1 GHz) / 3 MHz (> 1 GHz)
- Frequency Span: Zero Span
- Sweep time: $> 120\%$ of the duration of the longest burst detected during the measurement of the RF Output Power
- Sweep points: Sweep time [μs] / (1 μs) with a maximum of 30 000
- Trigger: Video (burst signals) or Manual (continuous signals)
- Detector: RMS

Step 2:

Set a window where the start and stop indicators match the start and end of the burst with the highest level and record the value of the power measured within this window. If the spurious emission to be measured is a continuous transmission, the measurement window shall be set to match the start and stop times of the sweep.

Step 3:

In case of conducted measurements on smart antenna systems (equipment with multiple transmit chains), step 2 needs to be repeated for each of the active transmit chains (A_{ch}).

Sum the measured power (within the observed window) for each of the active transmit chains.

Step 4:

The value defined in step 3 shall be compared to the limits defined in table 4 or table 12.

Test Data**Environmental Conditions**

Temperature:	24.1 °C
Relative Humidity:	51 %
ATM Pressure:	101.2 kPa

The testing was performed by Ada Yu on 2017-07-06.

Test Mode: Transmitting in 802.11b mode (worst case).

30 MHz ~ 12.75 GHz:

Frequency (MHz)	Receiver Reading (dBμV)	Turntable Angle Degree	Rx Antenna		Substituted			Absolute Level (dBm)	EN 300 328	
			Height (cm)	Polar (H/V)	Submitted Level (dBm)	Cable Loss (dB)	Antenna Gain (dB)		Limit (dBm)	Margin (dB)
Low Channel										
720.73	30.17	49	137	H	-66.31	0.30	4.35	-62.26	-54	8.26
720.73	28.93	350	216	V	-64.95	0.30	4.35	-60.90	-54	6.90
4824.00	46.97	86	119	H	-56.17	0.64	10.16	-46.65	-30	16.65
4824.00	48.42	91	102	V	-56.38	0.64	10.16	-46.86	-30	16.86
High Channel										
720.73	30.26	251	207	H	-66.22	0.30	4.35	-62.17	-54	8.17
720.73	28.43	143	190	V	-65.45	0.30	4.35	-61.40	-54	7.40
4944.00	47.10	316	212	H	-55.78	0.64	10.26	-46.16	-30	16.16
4944.00	48.59	154	122	V	-55.90	0.64	10.26	-46.28	-30	16.28

Note:

Absolute Level = Submitted Level - Cable loss + Antenna Gain

Margin = Limit- Absolute Level

ETSI EN 300 328 V2.1.1 (2016-11) Clause 4.3.2.10 – RECEIVER SPURIOUS EMISSIONS

Applicable Standard

According to ETSI EN 300 328 V2.1.1 (2016-11) Clause 4.3.2.10.2, the receiver spurious emissions are emissions at any frequency when the equipment is in receive mode.

The spurious emissions of the receiver shall not exceed the values given in the following table

Frequency range	Maximum power, e.r.p.	Measurement bandwidth
30 MHz to 1 GHz	-57 dBm	100 kHz
1 GHz to 12,75 GHz	-47 dBm	1 MHz

NOTE: In case of equipment with antenna connectors, these limits apply to emissions at the antenna port (conducted). For emissions radiated by the cabinet or for emissions radiated by integral antenna equipment (without antenna connectors), these limits are e.r.p. for emissions up to 1 GHz and e.i.r.p. for emissions above 1 GHz.

Test Procedure

Pre-scan:

The procedure in step 1 to step 4 below shall be used to identify potential unwanted emissions of the UUT.

Step 1:

The sensitivity of the spectrum analyser should be such that the noise floor is at least 12 dB below the limits given in table 5 or table 13.

Step 2:

The emissions over the range 30 MHz to 1 000 MHz shall be identified.

Spectrum analyser settings:

- Resolution bandwidth: 100 kHz
- Video bandwidth: 300 kHz
- Filter type: 3 dB (Gaussian)
- Detector mode: Peak
- Trace Mode: Max Hold
- Sweep Points: $\geq 19\,400$
- Sweep time: Auto

Note: Wait for the trace to stabilize. Any emissions identified during the sweeps above and that fall within the 6 dB range below the applicable limit or above, shall be individually measured using the procedure in clause 5.4.10.2.1.3 and compared to the limits given in table 5 or table 13.

Step 3:

The emissions over the range 1 GHz to 12,75 GHz shall be identified.

Spectrum analyser settings:

- Resolution bandwidth: 1 MHz
- Video bandwidth: 3 MHz
- Filter type: 3 dB (Gaussian)
- Detector mode: Peak

- Trace Mode: Max Hold
- Sweep Points: $\geq 23\,500$; for spectrum analysers not supporting this high number of sweep points, the frequency band may be segmented
- Sweep time: Auto

Wait for the trace to stabilize. Any emissions identified during the sweeps above that fall within the 6 dB range below the applicable limit or above, shall be individually measured using the procedure in clause 5.4.10.2.1.3 and compared to the limits given in table 5 or table 13.

Frequency Hopping equipment may generate a block (or several blocks) of spurious emissions anywhere within the spurious domain. If this is the case, only the highest peak of each block of emissions shall be measured using the procedure in clause 5.4.10.2.1.3.

Step 4:

In case of conducted measurements on smart antenna systems (equipment with multiple receive chains), step 2 and step 3 need to be repeated for each of the active receive chains A_{ch} . The limits used to identify emissions during this pre-scan need to be reduced by $10 \times \log_{10} A_{ch}$.

Measurement of the emissions identified during the pre-scan:

The procedure in step 1 to step 4 below shall be used to accurately measure the individual unwanted emissions identified during the pre-scan measurements above. This method assumes the spectrum analyser has a Time Domain Power function.

Step 1:

The level of the emissions shall be measured using the following spectrum analyser settings:

- Measurement Mode: Time Domain Power
- Centre Frequency: Frequency of the emission identified during the pre-scan
- Resolution Bandwidth: 100 kHz (< 1 GHz) / 1 MHz (> 1 GHz)
- Video Bandwidth: 300 kHz (< 1 GHz) / 3 MHz (> 1 GHz)
- Frequency Span: Zero Span
- Sweep mode: Single Sweep
- Sweep time: 30 ms
- Sweep points: $\geq 30\,000$
- Trigger: Video (for burst signals) or Manual (for continuous signals)
- Detector: RMS

Step 2:

Set a window where the start and stop indicators match the start and end of the burst with the highest level and record the value of the power measured within this window. If the spurious emission to be measured is a continuous transmission, the measurement window shall be set to the start and stop times of the sweep.

Step 3:

In case of conducted measurements on smart antenna systems (equipment with multiple receive chains), step 2 needs to be repeated for each of the active receive chains A_{ch} .

Sum the measured power (within the observed window) for each of the active receive chains.

Step 4:

The value defined in step 3 shall be compared to the limits defined in table 5 and table 13.

Test Data

Environmental Conditions

Temperature:	24.1 °C
Relative Humidity:	51 %
ATM Pressure:	101.2 kPa

The testing was performed by Ada Yu on 2017-07-06.

Test Mode: Receiving in 802.11b mode (worst case)

30 MHz ~ 12.75 GHz

Frequency (MHz)	Receiver Reading (dBµV)	Turntable Angle Degree	Rx Antenna		Substituted			Absolute Level (dBm)	EN 300 328	
			Height (cm)	Polar (H/V)	Submitted Level (dBm)	Cable Loss (dB)	Antenna Gain (dB)		Limit (dBm)	Margin (dB)
Low Channel										
721.08	26.37	18	215	H	-70.10	0.30	4.36	-66.04	-57	9.04
721.08	23.84	140	123	V	-70.03	0.30	4.36	-65.97	-57	8.97
1637.84	44.49	76	217	H	-65.96	0.38	8.42	-57.92	-47	10.92
1637.84	46.40	163	147	V	-65.94	0.38	8.42	-57.90	-47	10.90
High Channel										
720.64	26.62	55	129	H	-69.86	0.30	4.35	-65.81	-57	8.81
720.64	24.05	293	125	V	-69.83	0.30	4.35	-65.78	-57	8.78
1726.43	44.75	284	105	H	-64.97	0.40	8.56	-56.81	-47	9.81
1726.43	46.20	259	133	V	-65.53	0.40	8.56	-57.37	-47	10.37

Note:

Absolute Level = Submitted Level - Cable loss + Antenna Gain

Margin = Limit- Absolute Level

ETSI EN 300 328 V2.1.1 (2016-11) Clause 4.3.2.11 – RECEIVER BLOCKING**Applicable Standard**

Receiver blocking is a measure of the ability of the equipment to receive a wanted signal on its operating channel without exceeding a given degradation in the presence of an unwanted signal (blocking signal) at frequencies other than those of the operating band.

While maintaining the minimum performance criteria as defined in clause 4.3.2.11.3, the blocking levels at specified frequency offsets shall be equal to or greater than the limits defined for the applicable receiver category provided in table 14, table 15 or table 16.

Table 14: Receiver Blocking parameters for Receiver Category 1 equipment

Wanted signal mean power from companion device (dBm)	Blocking signal frequency (MHz)	Blocking signal power (dBm) (see note 2)	Type of blocking signal
$P_{min} + 6$ dB	2 380 2 503,5	-53	CW
$P_{min} + 6$ dB	2 300 2 330 2 360	-47	CW
$P_{min} + 6$ dB	2 523,5 2 553,5 2 583,5 2 613,5 2 643,5 2 673,5	-47	CW

NOTE 1: P_{min} is the minimum level of the wanted signal (in dBm) required to meet the minimum performance criteria as defined in clause 4.3.2.11.3 in the absence of any blocking signal.

NOTE 2: The levels specified are levels in front of the UUT antenna. In case of conducted measurements, the levels have to be corrected by the actual antenna assembly gain.

Table 15: Receiver Blocking parameters receiver category 2 equipment

Wanted signal mean power from companion device (dBm)	Blocking signal frequency (MHz)	Blocking signal power (dBm) (see note 2)	Type of blocking signal
$P_{min} + 6$ dB	2 380 2 503,5	-57	CW
$P_{min} + 6$ dB	2 300 2 583,5	-47	CW

NOTE 1: P_{min} is the minimum level of the wanted signal (in dBm) required to meet the minimum performance criteria as defined in clause 4.3.2.11.3 in the absence of any blocking signal.

NOTE 2: The levels specified are levels in front of the UUT antenna. In case of conducted measurements, the levels have to be corrected by the actual antenna assembly gain.

Table 16: Receiver Blocking parameters receiver category 3 equipment

Wanted signal mean power from companion device (dBm)	Blocking signal frequency (MHz)	Blocking signal power (dBm) (see note 2)	Type of blocking signal
$P_{min} + 12$ dB	2 380 2 503,5	-57	CW
$P_{min} + 12$ dB	2 300 2 583,5	-47	CW

NOTE 1: P_{min} is the minimum level of the wanted signal (in dBm) required to meet the minimum performance criteria as defined in clause 4.3.2.11.3 in the absence of any blocking signal.

NOTE 2: The levels specified are levels in front of the UUT antenna. In case of conducted measurements, the levels have to be corrected by the actual antenna assembly gain.

Test Procedure

According to ETSI EN 300 328 V2.1.1 (2016-11) Clause 5.4.11.2

Test Setup Block diagram

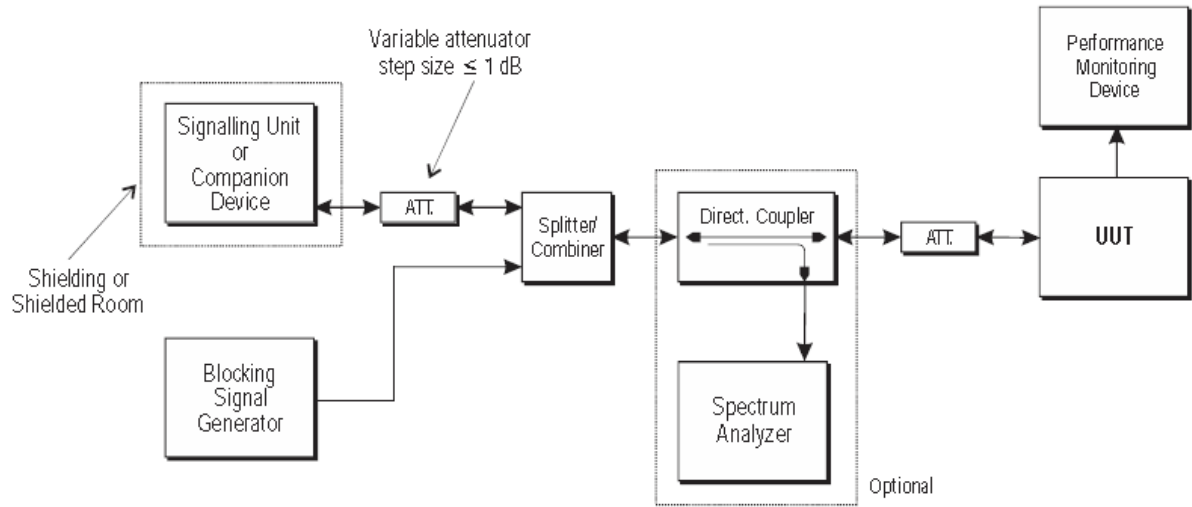

Test data

Environmental Conditions

Temperature:	24.2 °C
Relative Humidity:	51 %
ATM Pressure:	101.2kPa

The testing was performed by Ada Yu on 2017-07-06.

Test Mode: Receiving in 802.11b mode (Data rate: 1Mbps).

Test Result: Compliant

Receiver category	Channel	Pmin (dBm)	Wanted signal Power from companion device (dBm)	Blocking signal Frequency (MHz)	Blocking signal Power(dBm)	PER (%)	Limit (%)
1 (See Note1)	Low	-91	-85	2380	-50(See Note2)	0.23	≤10.00
				2503.5	-50(See Note2)	0.11	≤10.00
				2300	-44(See Note2)	0.22	≤10.00
				2330	-44(See Note2)	0.17	≤10.00
				2360	-44(See Note2)	0.15	≤10.00
				2523.5	-44(See Note2)	0.21	≤10.00
				2553.5	-44(See Note2)	0.19	≤10.00
				2583.5	-44(See Note2)	0.17	≤10.00
				2613.5	-44(See Note2)	0.20	≤10.00
				2643.5	-44(See Note2)	0.18	≤10.00
	2673.5	-44(See Note2)	0.11	≤10.00			
	High	-91	-85	2380	-50(See Note2)	0.21	≤10.00
				2503.5	-50(See Note2)	0.23	≤10.00
				2300	-44(See Note2)	0.18	≤10.00
				2330	-44(See Note2)	0.16	≤10.00
				2360	-44(See Note2)	0.14	≤10.00
				2523.5	-44(See Note2)	0.22	≤10.00
				2553.5	-44(See Note2)	0.16	≤10.00
				2583.5	-44(See Note2)	0.17	≤10.00
				2613.5	-44(See Note2)	0.21	≤10.00
2643.5				-44(See Note2)	0.16	≤10.00	
2673.5	-44(See Note2)	0.13	≤10.00				

Note1: The e.i.r.p > 10dBm
 Note2: The actual assembly gain is 3.0dBi.

EXHIBIT A - E.1 INFORMATION AS REQUIRED BY ETSI EN 300 328 V2.1.1, CLAUSE 5.4.1

In accordance with EN 300 328, clause 5.4.1, the following information is provided by the manufacturer.

a) The type of modulation used by the equipment:

- FHSS
 other forms of modulation

b) In case of FHSS modulation:

In case of non-Adaptive Frequency Hopping equipment:

The number of Hopping Frequencies: _____.

In case of Adaptive Frequency Hopping Equipment:

The maximum number of Hopping Frequencies: _____;

The minimum number of Hopping Frequencies: _____;

The (average) Dwell Time: _____;

c) Adaptive / non-adaptive equipment:

- non-adaptive Equipment
 adaptive Equipment without the possibility to switch to a non-adaptive mode
 adaptive Equipment which can also operate in a non-adaptive mode

d) In case of adaptive equipment:

The maximum Channel Occupancy Time implemented by the equipment: _____ms

- The equipment has implemented an LBT based DAA mechanism

In case of equipment using modulation different from FHSS:

- The equipment is Frame Based equipment
 The equipment is Load Based equipment
 The equipment can switch dynamically between Frame Based and Load Based equipment

The CCA time implemented by the equipment: _____ μ s

- The equipment has implemented a non-LBT based DAA mechanism
 The equipment can operate in more than one adaptive mode

e) In case of non-adaptive Equipment:

The maximum RF Output Power (e.i.r.p.): _____dBm

The maximum (corresponding) Duty Cycle: _____%

Equipment with dynamic behaviour, that behaviour is described here. (e.g. the different combinations of duty cycle and corresponding power levels to be declared):
_____.

f) The worst case operational mode for each of the following tests:

RF Output Power: 17.61dBm ;
 Power Spectral Density 7.67dBm/MHz ;
 Duty cycle, Tx-Sequence, Tx-gap N/A ;
 Accumulated Transmit time, Frequency Occupation & Hopping Sequence (only for FHSS equipment) N/A ;
 Hopping Frequency Separation (only for FHSS equipment) N/A ;
 Medium Utilisation N/A ;
 Adaptivity Compliance ;
 Receiver Blocking Compliance ;
 Nominal Channel Bandwidth 36.51MHz ;
 Transmitter unwanted emissions in the OOB domain -33.00dBm/MHz ;
 Transmitter unwanted emissions in the spurious domain -60.90 dBm ;
 Receiver spurious emissions -65.78dBm ;

g) The different transmit operating modes (tick all that apply):

- Operating mode 1: Single Antenna Equipment
 Equipment with only 1 antenna
 Equipment with 2 diversity antennas but only one antenna active at any moment in time
 Smart Antenna Systems with 2 or more antennas, but operating in a (legacy) mode where only 1 antenna is used.
 (e.g. IEEE 802.11™ [i.3] legacy mode in smart antenna systems)
- Operating mode 2: Smart Antenna Systems - Multiple Antennas without beam forming
 Single spatial stream / Standard throughput / (e.g. IEEE 802.11™ [i.3] legacy mode)
 High Throughput (> 1 spatial stream) using Occupied Channel Bandwidth 1
 High Throughput (> 1 spatial stream) using Occupied Channel Bandwidth 2
 Note: Add more lines if more channel bandwidths are supported.
- Operating mode 3: Smart Antenna Systems - Multiple Antennas with beam forming
 Single spatial stream / Standard throughput (e.g. IEEE 802.11™ [i.3] legacy mode)
 High Throughput (> 1 spatial stream) using Occupied Channel Bandwidth 1
 High Throughput (> 1 spatial stream) using Occupied Channel Bandwidth 2
 Note: Add more lines if more channel bandwidths are supported.

h) In case of Smart Antenna Systems:

The number of Receive chains: _____ ;
 The number of Transmit chains: _____ ;

- symmetrical power distribution
 asymmetrical power distribution

In case of beam forming, the maximum (additional) beam forming gain: N/A ;

Note: The additional beam forming gain does not include the basic gain of a single antenna.

i) Operating Frequency Range(s) of the equipment:

Operating Frequency Range 1: 2412 MHz to 2472 MHz
 Operating Frequency Range 2: 2422 MHz to 2462 MHz

Note: Add more lines if more Frequency Ranges are supported.

j) Nominal Channel Bandwidth(s):

Nominal Channel Bandwidth 1: 15.23 MHz
 Nominal Channel Bandwidth 2: 18.07 MHz
 Nominal Channel Bandwidth 3: 18.33 MHz
 Nominal Channel Bandwidth 4: 36.51 MHz

Note: Add more lines if more channel bandwidths are supported.

k) Type of Equipment (stand-alone, combined, plug-in radio device, etc.):

- Stand-alone
 Combined Equipment (Equipment where the radio part is fully integrated within another type of equipment)
 Plug-in radio device (Equipment intended for a variety of host systems)
 Other _____;

l) The normal and extreme operating conditions that apply to the equipment:**Normal operating conditions (if applicable):**

Operating temperature: 30 °C

Other (please specify if applicable):

Extreme operating conditions:

Operating temperature range: Minimum: -25 °C Maximum: +85 °C

Other (please specify if applicable): Minimum: Maximum:

Details provided are for the: stand-alone equipment
 combined (or host) equipment
 test jig

m) The intended combination(s) of the radio equipment power settings and one or more antenna assemblies and their corresponding e.i.r.p levels:

Antenna Type:

- Integral Antenna (information to be provided in case of conducted measurements)

Antenna Gain: 3.0 dBi

If applicable, additional beamforming gain (excluding basic antenna gain): _____ dB

- Temporary RF connector provided
 No temporary RF connector provided

- Dedicated Antennas (equipment with antenna connector)
- Single power level with corresponding antenna(s)
- Multiple power settings and corresponding antenna(s)

Number of different Power Levels:

Power Level 1: dBm
 Power Level 2: dBm
 Power Level 3: dBm

Note 1: Add more lines in case the equipment has more power levels.
 Note 2: These power levels are conducted power levels (at antenna connector).

For each of the Power Levels, provide the intended antenna assemblies, their corresponding gains (G) and the resulting e.i.r.p. levels also taking into account the beamforming gain (Y) if applicable

Power Level 1: dBm

Number of antenna assemblies provided for this power level:

Assembly #	Gain (dBi)	e.i.r.p.(dBm)	Part number or model name
1			
2			
3			
4			

NOTE 3: Add more rows in case more antenna assemblies are supported for this power level.

Power Level 2: dBm

Number of antenna assemblies provided for this power level:

Assembly #	Gain (dBi)	e.i.r.p.(dBm)	Part number or model name
1			
2			
3			
4			

NOTE 4: Add more rows in case more antenna assemblies are supported for this power level.

Power Level 3: dBm

Number of antenna assemblies provided for this power level:

Assembly #	Gain (dBi)	e.i.r.p.(dBm)	Part number or model name
1			
2			
3			
4			

NOTE 5: Add more rows in case more antenna assemblies are supported for this power level.

n) The nominal voltages of the stand-alone radio equipment or the nominal voltages of the combined (host) equipment or test jig in case of plug-in devices:

Details provided are for the: stand-alone equipment
 combined (or host) equipment
 test jig

Supply Voltage AC mains State AC voltage _____ V
 DC State DC voltage _____ 12 _____ V

In case of DC, indicate the type of power source

- Internal Power Supply
 External Power Supply or AC/DC adapter
 Battery
 Other: _____.

o) Describe the test modes available which can facilitate testing:

_____ Continuous transmitting and normal operation _____

p) The equipment type (e.g. Bluetooth®, IEEE 802.11™ [i.3], IEEE 802.15.4™ [i.4], proprietary, etc.):

_____ IEEE 802.11™ [i.3] _____

q) If applicable, the statistical analysis referred to in clause 5.4.1 q)

(to be provided as separate attachment)

r) If applicable, the statistical analysis referred to in clause 5.4.1 r)

(to be provided as separate attachment)

s) Geo-location capability supported by the equipment:

- Yes
 The geographical location determined by the equipment as defined in clause 4.3.1.13.2 or clause 4.3.2.12.2 is not accessible to the user.
 No

t) Describe the minimum performance criteria that apply to the equipment (see clause 4.3.1.12.3 or clause 4.3.2.11.3):

EXHIBIT B - EUT PHOTOGRAPHS

EUT – Front View



EUT – Rear View



EUT – Top View



EUT – Bottom View



EUT – Left View



EUT – Right View

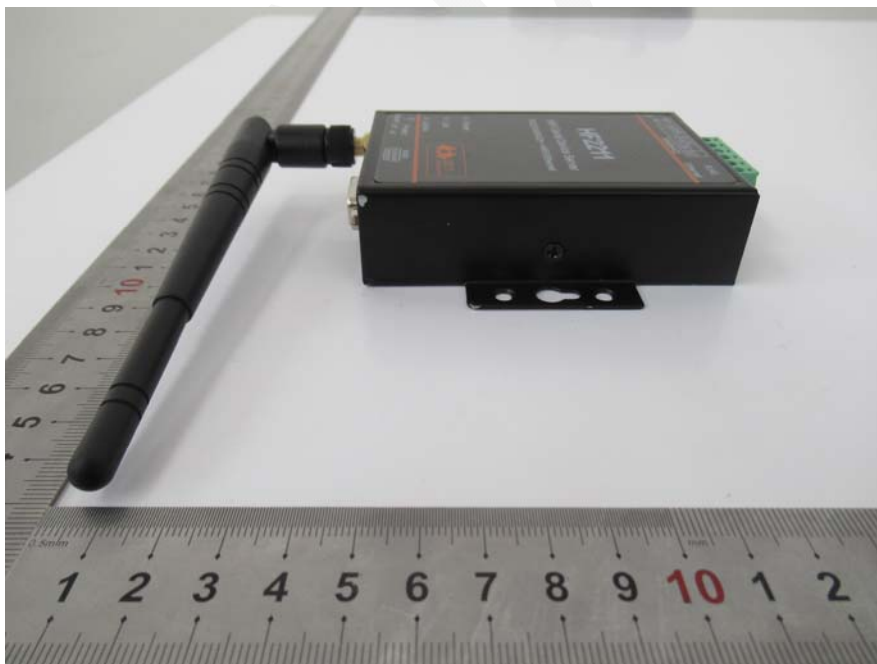

EUT – Cover off View-1



EUT – Cover off View-2



EUT – Cover off View-3



EUT – Cover off View-4



EUT – PCB Top View

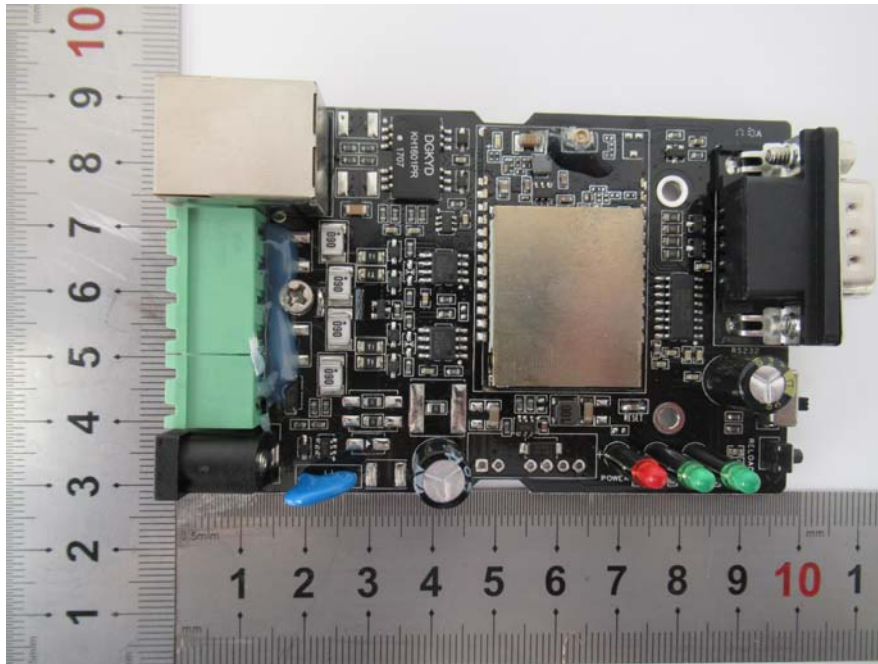

EUT – PCB Top Shielding off View

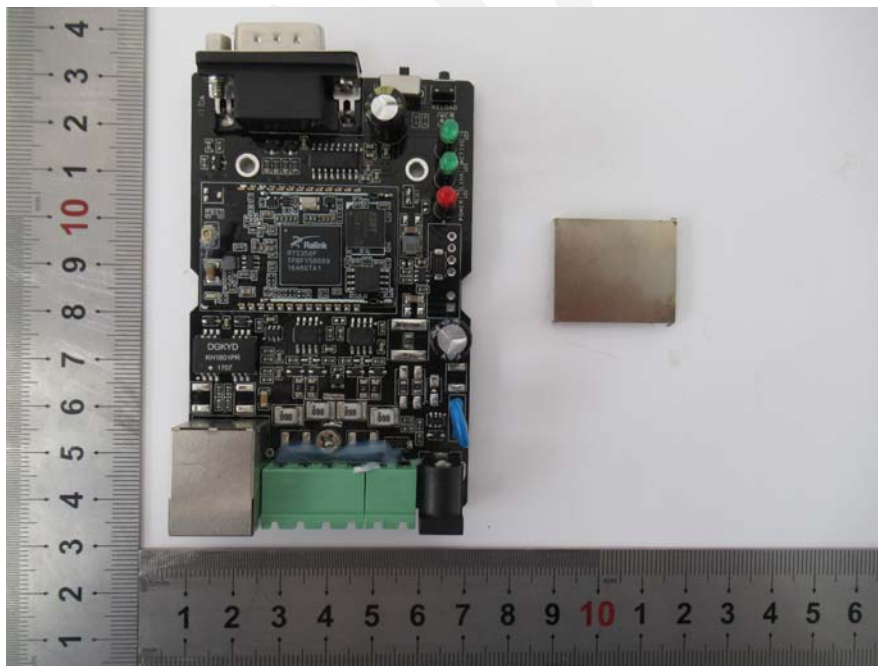

EUT – PCB Bottom View

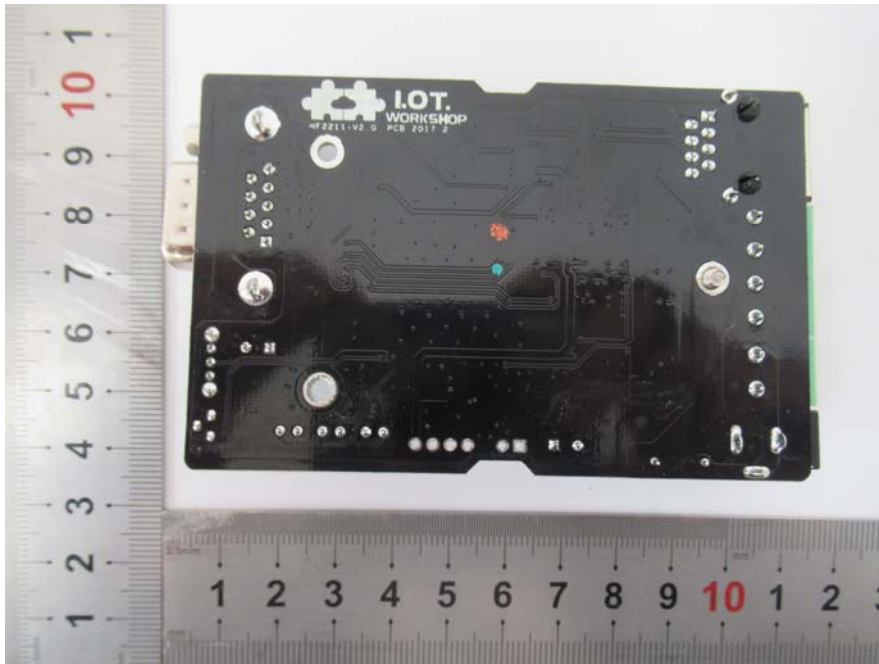

EUT – Wi-Fi Module Top View

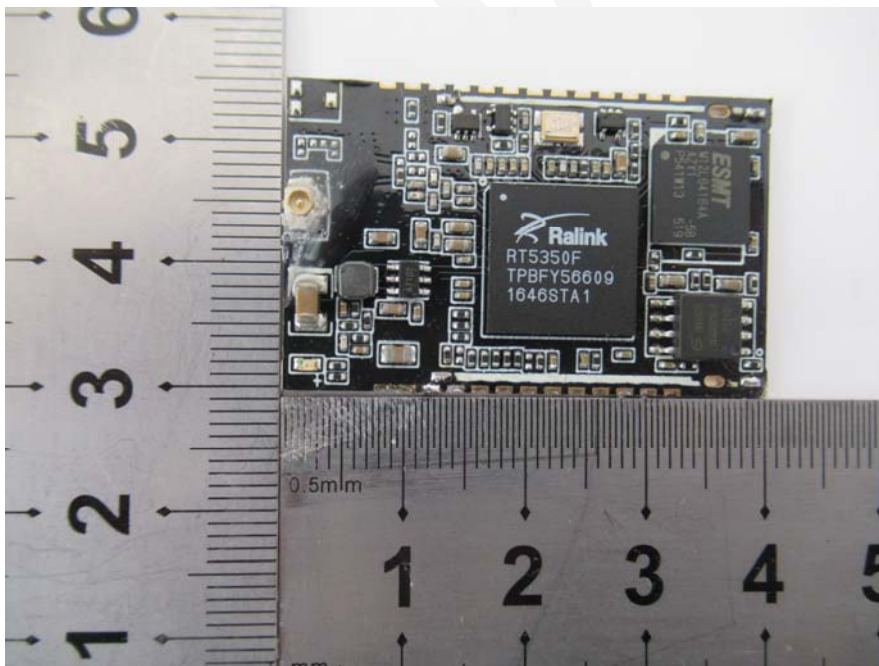

EUT – Wi-Fi Module Bottom View

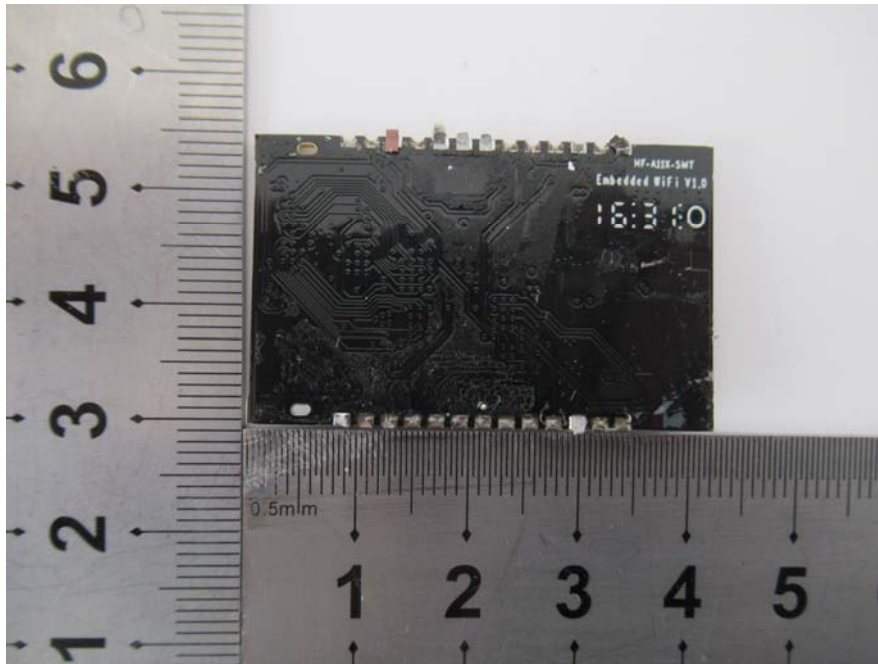
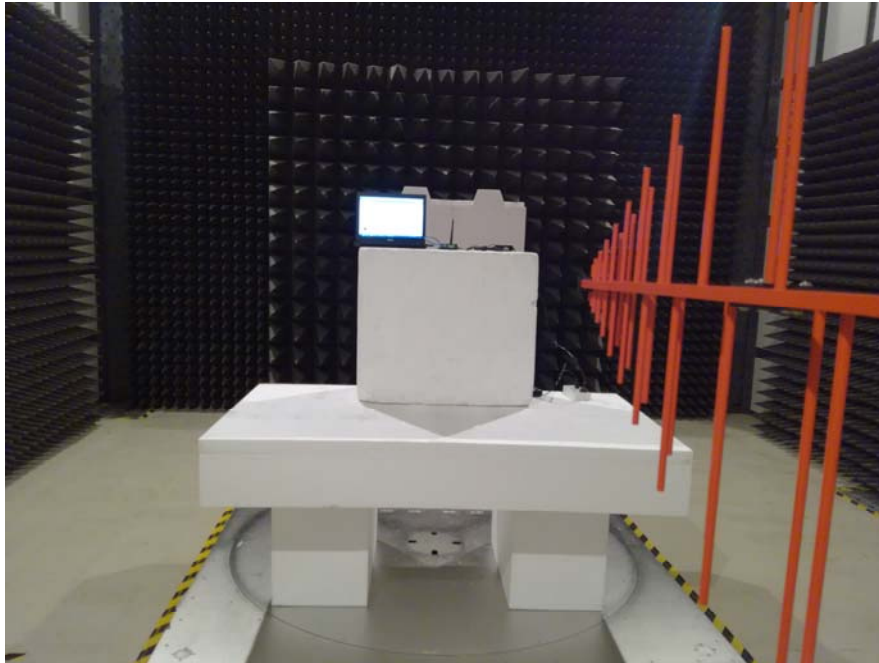
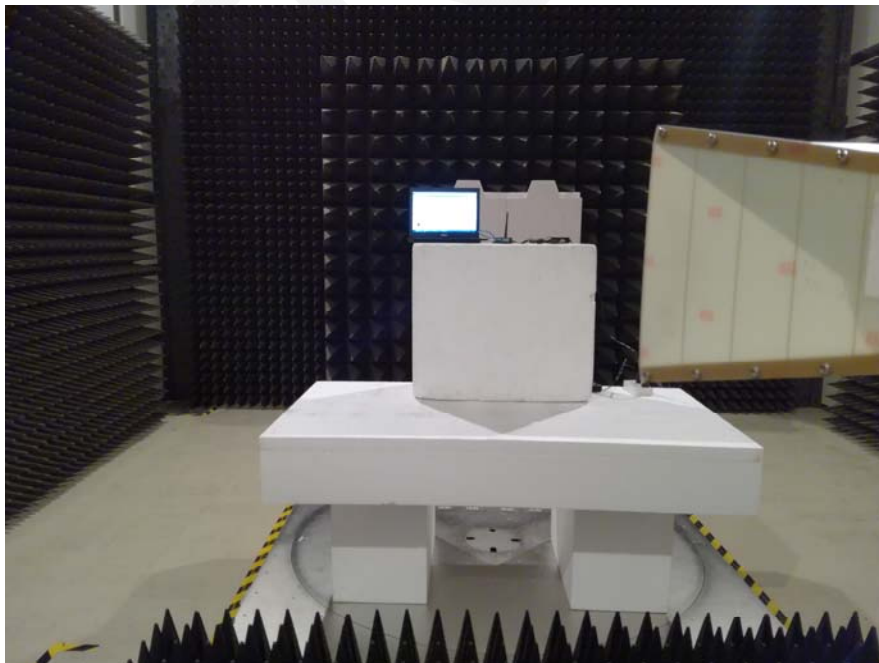

EXHIBIT C - TEST SETUP PHOTOGRAPHS

Radiated Spurious Emissions Test View (Below 1GHz)



Radiated Spurious Emissions Test View (Above 1GHz)



*******END OF REPORT*******