

HF-LPB125

Low Power Wi-Fi Module User Manual

V 1.2



Overview of Characteristic

- ◇ Support IEEE802.11b/g/n Wireless Standards
- ◇ Based on Self-developed High Cost SOC
- ◇ Ultra-Low-Power for Battery Applications with Excellent Power Save Scheme
- ◇ Support UART/GPIO Data Communication Interface
- ◇ Support Work As STA/APMode
- ◇ Support Smart Link Function (APP program provide)
- ◇ Support Wireless and Remote Firmware Upgrade Function
- ◇ Support Internal/External(I-PEX) Antenna Option
- ◇ Single +5V Power Supply, +5V UART Voltage.
- ◇ Smallest Size: 41.3mm x 24.1mm x 6mm, 2x4 Pin 2.54mm pin header or 4 Pin 2.5mm Header
- ◇ FCC/CE/SRRC Certificated

TABLE OF CONTENTS

LIST OF FIGURES	5
LIST OF TABLES	5
HISTORY	6
1. PRODUCT OVERVIEW	7
1.1. General Description	7
1.1.1 Device Features.....	7
1.1.2 Device Parameters	8
1.1.3 Key Application	8
1.2. Hardware Introduction	9
1.2.1. Pins Definition	9
1.2.2. Electrical Characteristics	10
1.2.3. Mechanical Size.....	11
1.2.4. External Antenna	12
1.2.5. Order Information.....	12
1.3. Typical Application	13
1.3.1. Hardware Typical Application	13
2. FUNCTIONAL DESCRIPTION	14
2.1. Wireless Networking	14
2.1.1. Basic Wireless Network Based On AP (Infrastructure)	14
2.1.2. Wireless Network Based On STA.....	14
2.2. Work Mode : Transparent Transmission Mode	15
2.3. Encryption	15
2.4. Parameters Configuration	15
2.5. Firmware Update	16
2.6. SOCKET B Function	16
2.7. Multi-TCP Link Connection (Reserved)	16
3. OPERATION GUIDELINE	18
3.1. Configuration	18
3.1.1. Open Web Management Interface	18
3.1.2. System Page.....	19
3.1.3. Work Mode Page	19
3.1.4. STA Setting Page	20
3.1.5. AP Setting Page	21
3.1.6. Other Setting Page	21
3.1.7. Account Management Page	22
3.1.8. Upgrade Software Page	22
3.1.9. Restart Page	22
3.1.10. Restore Page	23
3.1.11. Internal Webpage.....	23

3.2. Usage Introduction	24
3.2.1. Software Debug Tools	24
3.2.2. Network Connection	24
3.2.3. Default Parameter Setting	24
3.2.4. Module Debug.....	25
3.3. Typical Application Examples	26
3.3.1. Wireless Control Application.....	26
3.3.2. Remote Management Application.....	26
3.3.3. Transparent Serial Port Application.....	27
4. AT+INSTRUCTION INTRODUCTION	28
4.1. Configuration Mode	28
4.1.1. Switch to Configuration Mode.....	28
4.2. AT+Instruction Set Overview	29
4.2.1. Instruction Syntax Format.....	29
4.2.2. AT+Instruction Set	30
4.2.2.1. AT+E	32
4.2.2.2. AT+WMODE	32
4.2.2.3. AT+ENTM	32
4.2.2.4. AT+MID	32
4.2.2.5. AT+VER	33
4.2.2.6. AT+BVER.....	33
4.2.2.7. AT+RELD	33
4.2.2.8. AT+FCLR	33
4.2.2.9. AT+Z.....	33
4.2.2.10. AT+H	33
4.2.2.11. AT+CFGTF.....	34
4.2.2.12. AT+UART	34
4.2.2.13. AT+NETP	35
4.2.2.14. AT+MAXSK	35
4.2.2.15. AT+TCPLK	35
4.2.2.16. AT+TCPTO.....	36
4.2.2.17. AT+TCPDIS.....	36
4.2.2.18. AT+SOCKB	36
4.2.2.19. AT+TCPDISB	37
4.2.2.20. AT+TCPTOB	37
4.2.2.21. AT+TCPLKB.....	38
4.2.2.22. AT+WSSSID.....	38
4.2.2.23. AT+WSKEY	38
4.2.2.24. AT+WANN	39
4.2.2.25. AT+WSMAC	39
4.2.2.26. AT+WSLK.....	40
4.2.2.27. AT+WSLQ	40
4.2.2.28. AT+WSCAN.....	40
4.2.2.29. AT+LANN	40

4.2.2.30.	AT+WAP	41
4.2.2.31.	AT+WAKEKEY	41
4.2.2.32.	AT+WADHCP	41
4.2.2.33.	AT+WALK	42
4.2.2.34.	AT+WALKIND	42
4.2.2.35.	AT+WAPMXSTA	42
4.2.2.36.	AT+OTA	43
4.2.2.37.	AT+UPURL	43
4.2.2.38.	AT+DISPS	43
4.2.2.39.	AT+PLANG	44
4.2.2.40.	AT+WEBU	44
4.2.2.41.	AT+WRMID	44
4.2.2.42.	AT+ASWD	44
4.2.2.43.	AT+SMTLK	45
4.2.2.44.	AT+SMEM	45
4.2.2.45.	AT+NDBGL	45
5.	PACKAGE INFORMATION	47
5.1.	Recommended Reflow Profile	47
5.2.	Device Handling Instruction (Module IC SMT Preparation)	47
5.3.	Shipping Information(TBD)	48
	APPENDIX A: HTTP PROTOCOL TRANSFER	49
A.1.	Sending HTTP Raw Data in Throughput Mode	49
	APPENDIX B: REFERENCES	50
B.1.	High-Flying Mass Production Tool	50
B.2.	SmartLink APP V7 Config Tool	50
B.3.	EVK Quick Start Guide	50
B.4.	Module Upgrade	50
B.5.	Other Tools	50
	APPENDIX C: CONTACT INFORMATION	51

LIST OF FIGURES

Figure 1.	HF-LPB125 Pins Map.....	9
Figure 2.	HF-LPB125 Mechanical Dimension	11
Figure 3.	HF-LPB125 External Antenna Example	12
Figure 4.	HF-LPB125 Order Information	12
Figure 5.	HF-LPB125 Hardware Typical Application	13
Figure 6.	HF-LPB125 Basic Wireless Network Structure	14
Figure 7.	HF-LPB125 STA Network Structure	14
Figure 8.	Socket B function demo	16
Figure 9.	Multi-TCP Link Data Transmission Structure.....	17
Figure 10.	Open Web Management page.....	18
Figure 11.	System Web Page	19
Figure 12.	Work Mode Page	19
Figure 13.	STA Setting Page	20
Figure 14.	STA Scan Page	20
Figure 15.	AP Setting Page	21
Figure 16.	Other Setting Page	21
Figure 17.	Account Page.....	22
Figure 18.	Upgrade SW page	22
Figure 19.	Restart Page	23
Figure 20.	Restore Page	23
Figure 21.	Internal Webpage	24
Figure 22.	STA Interface Debug Connection	24
Figure 23.	AP Interface Debug Connection	24
Figure 24.	“CommTools” Serial Debug Tools	25
Figure 25.	“TCPUDPDbg” Tools Create Connection	25
Figure 26.	“TCPUDPDbg” Tools Setting	26
Figure 27.	“TCPUDPDbg” Tools Connection	26
Figure 28.	Wireless Control Application.....	26
Figure 29.	Remote Management Application.....	27
Figure 30.	Transparent Serial Port Application	27
Figure 31.	HF-LPB125 Default UART Port Parameters	28
Figure 32.	Switch to Configuration Mode.....	28
Figure 33.	”AT+H” Instruction for Help	29
Figure 34.	Reflow Soldering Profile	47
Figure 35.	Shipping Information	48

LIST OF TABLES

Table1.	HF-LPB125 Module Technical Specifications	8
Table2.	HF-LPB125 Pins Definition.....	9
Table3.	Absolute Maximum Ratings:.....	10

Table4. Power Supply & Power Consumption:11
 Table5. HF-LPB125 External Antenna Parameters12
 Table6. HF-LPB125 Web Access Default Setting18
 Table7. Error Code Description30
 Table8. AT+Instruction Set List30
 Table9. Reflow Soldering Parameter47

HISTORY

- Ed. V1.0** 03-02-2016 First Version.
- Ed. V1.1** 10-25-2016 Update boot GPIO requirement.
- Ed. V1.2** 12-19-2016 Update 2.09-6 firmware webpage function, add the whole function into this manual.

1. PRODUCT OVERVIEW

1.1. General Description

The HF-LPB125 is a fully self-contained small form-factor, single stream, 802.11b/g/n Wi-Fi module, which provide a wireless interface to any equipment with a Serial/SPI interface for data transfer. HF-LPB125 integrate MAC, baseband processor, RF transceiver with power amplifier in hardware and all Wi-Fi protocol and configuration functionality and networking stack, in embedded firmware to make a fully self-contained 802.11b/g/n Wi-Fi solution for a variety of applications.

The HF-LPB125 employs the world's lowest power consumption embedded architecture. It has been optimized for all kinds of client applications in the home automation, smart grid, handheld device, personal medical application and industrial control that have lower data rates, and transmit or receive data on an infrequent basis.

The HF-LPB125 integrates all Wi-Fi functionality into a low-profile, 41.3mm x 24.1mm x 6mm SMT module package that can be easily mounted on main PCB with application specific circuits. Also, module provides built-in antenna, external antenna option.

1.1.1 Device Features

- Single stream Wi-Fi @ 2.4 GHz with support for WEP security mode as well as WPA/WPA2
- Based on Self-developed High Cost Performance MCU
- Ultra-low-power operation with all kinds of power-save modes.
- Includes all the protocol and configuration functions for Wi-Fi connectivity.
- Support STA/AP Mode
- Support Smart Link Function
- Support Wireless and Remote Firmware Upgrade Function
- Integrated PCB antenna or I-PEX antenna connector options.
- Compact surface mount module 41.3mm x 24.1mm x 6mm.
- Full IPv4 stack.
- Low power RTOS and drivers.
- CE/FCC/SRRC Certified.
- RoHS compliant.
- Single supply – 5V operation.

1.1.2 Device Parameters

Table1. HF-LPB125 Module Technical Specifications

Class	Item	Parameters
Wireless Parameters	Certification	FCC/CE/SRRC
	Wireless standard	802.11 b/g/n
	Frequency range	2.412GHz-2.484GHz
	Transmit Power	802.11b: +16 +/-2dBm (@11Mbps)
		802.11g: +14 +/-2dBm (@54Mbps)
		802.11n: +13 +/-2dBm (@HT20, MCS7)
	Receiver Sensitivity	802.11b: 87- dBm (@11Mbps ,CCK)
802.11g: -73 dBm (@54Mbps, OFDM)		
802.11n: -71 dBm (@HT20, MCS7)		
Antenna Option	External:I-PEX Connector	
	Internal:On-board PCB antenna	
Hardware Parameters	Data Interface	UART
		GPIO
	Operating Voltage	4.75~6V
	Operating Current	Peak (Continuous TX): 280mA
		Average(STA, Continuous TX): 100mA
		Average(STA, No TX data). 30mA
	Operating Temp.	-20°C - 85°C
Storage Temp.	-40°C - 125°C	
Dimensions and Size	41.3mm x 24.1mm x 6mm	
External Interface	2x4 pin 2.54mm PIN or 4pin 2.5mm header	
Software Parameters	Network Type	STA/AP
	Security Mechanisms	WEP/WPA-PSK/WPA2-PSK
	Encryption	WEP64/WEP128/TKIP/AES
	Update Firmware	Local Wireless, Remote
	Customization	Support SDK for application develop
	Network Protocol	IPv4, TCP/UDP/HTTP
	User Configuration	AT+instruction set. Android/ iOS Smart Link APP tools

1.1.3 Key Application

- Remote equipment monitoring
- Asset tracking and telemetry
- Security
- Industrial sensors and controls
- Home automation
- Medical devices

1.2. Hardware Introduction

1.2.1. Pins Definition

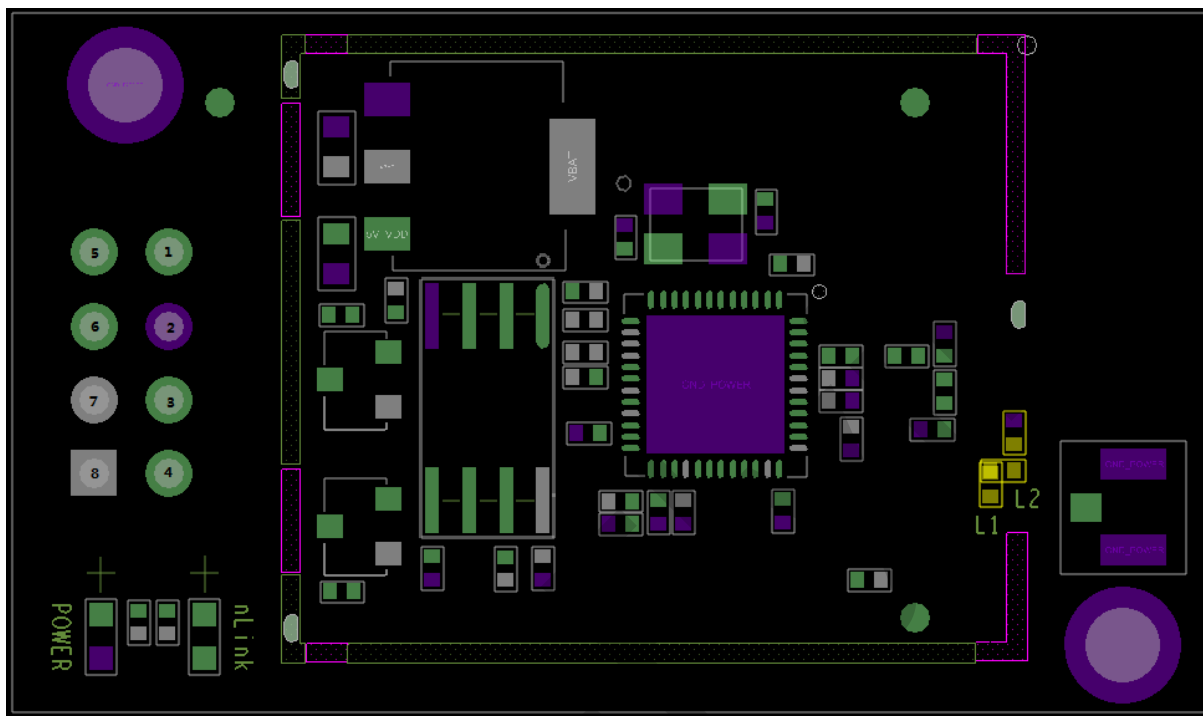

Figure 1. HF-LPB125 Pins Map

Table2. HF-LPB125 Pins Definition

Pin	Description	Net Name	Signal Type	Comments
1	+5V Power	DVDD	Power	5V@250mA
2	Ground	GND	Power	
3	UART0	UART0_RX	I,PU	5V UART0 Communication Input GPIO_19
4	UART0	UART0_TX	O,PU	5V UART0 Communication Output GPIO_20
5	Multi-Function	nReload	I,PU	3.3V, nReload Function GPIO_2, Leave it if not use Detailed functions see <Notes>
6	Module Reset	EXT_RESETn	I,PU	3.3V, "Low" effective hardware reset input. Leave it if not use
7	UART1_TXD	GPIO_5	I/O,PU	3.3V UART1 Debug Output GPIO_5, Leave it if not use

				Detailed functions see <Notes>
8	UART1_RXD	GPIO_6	I/O	3.3V UART1 Debug Input GPIO_6, Leave it if not use Detailed functions see <Notes>

<Notes>

Module Pin4/PIN7 must be high when bootup. otherwise it will fail to work.

I — Input; O — Output

PU—Internal Resistor Pull Up; I/O: Digital I/O; Power—Power Supply

nReload Pin (Button) function:

1. When this pin is set to “low” during module boot up, the module will enter wireless firmware and config upgrade mode. This mode is used for customer manufacture. (See Appendix D to download software tools for customer batch configuration and upgrade firmware during mass production)
2. After module is powered up, short press this button (“Low” <= 2s) to make the module go into “Smart Link “ config mode, waiting for APP to set password and other information. (See Appendix D to download SmartLink APP)
3. After module is powered up, long press this button (“Low” >= 4s) to make the module recover to factory setting.

High-Flying strongly suggest customer fan out this pin to connector or button for “Manufacture” and “ Smart Link” application.

UART1 Debug :

1. Enable UART1 log information output by AT+NDBGL=1,1 via UART0, UART1 baud rate is fixed at 115200.
2. After UART1 is enabled, it will output system run log information and it can direct process AT command(No need to enter command mode like UART0)

1.2.2. Electrical Characteristics

Table3. Absolute Maximum Ratings:

Parameter	Condition	Min.	Typ.	Max.	Unit
Storage temperature range		-40		125	°C
Maximum soldering temperature	IPC/JEDEC J-STD-020			260	°C
Supply voltage		4.75		6	V
Voltage on any I/O pin		0		5/3.3	V
ESD (Human Body Model HBM)	TAMB=25°C			2.5	KV
ESD (MM)	TAMB=25°C			0.25	KV

Table4. Power Supply & Power Consumption:

Parameter	Condition	Min.	Typ.	Max.	Unit
Operating Supply voltage		4.75	5	6	V
Supply current, peak	Continuous Tx		280		mA
Supply current,	STA No data transfer		30		mA
Supply current,	STA Continuous data transfer		100		mA
Supply current,	AP		120		mA

1.2.3. Mechanical Size

HF-LPB125 modules physical size (Unit: mm) as follows:

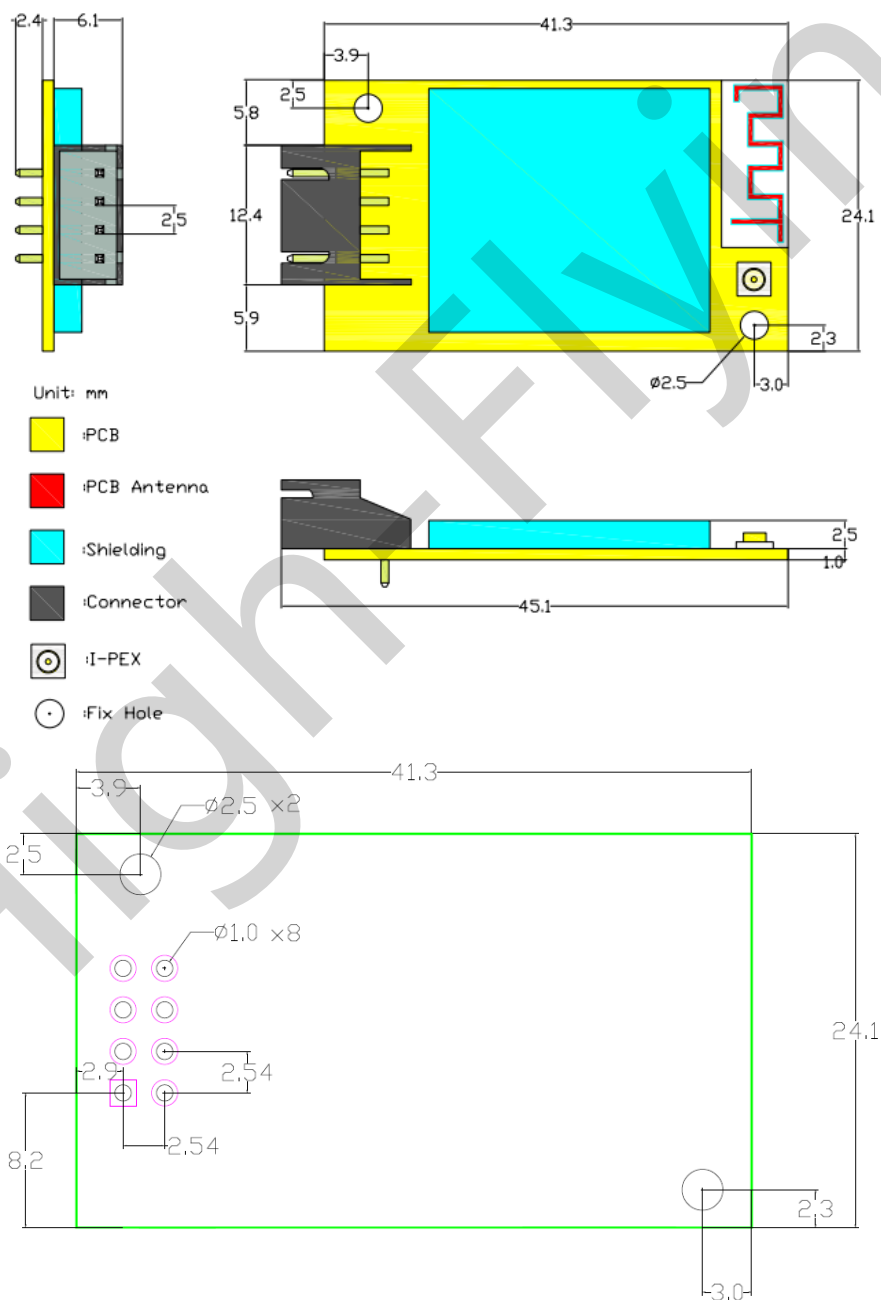

Figure 2. HF-LPB125 Mechanical Dimension

1.2.4. External Antenna

HF-LPB125 module supports internal antenna and external antenna(I-PEX) option for user dedicated application.

If user select external antenna, HF-LPB125 modules must be connected to the 2.4G antenna according to IEEE 802.11b/g/n standards. We can provide external antenna if needed. Contact with our salesman.



Figure 3. HF-LPB125 External Antenna Example

The antenna parameters required as follows:

Table5. HF-LPB125 External Antenna Parameters

Item	Parameters
Frequency range	2.4~2.5GHz
Impedance	50 Ohm
VSWR	2 (Max)
Return Loss	-10dB (Max)
Connector Type	I-PEX or populate directly

1.2.5. Order Information

Base on customer detailed requirement, HF-LPB125 series modules provide different variants and physical type for detailed application.

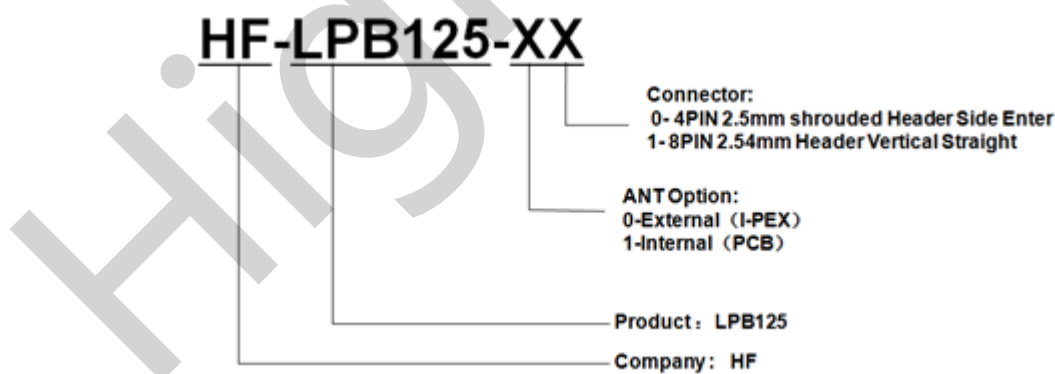

Figure 4. HF-LPB125 Order Information

1.3. Typical Application

1.3.1. Hardware Typical Application

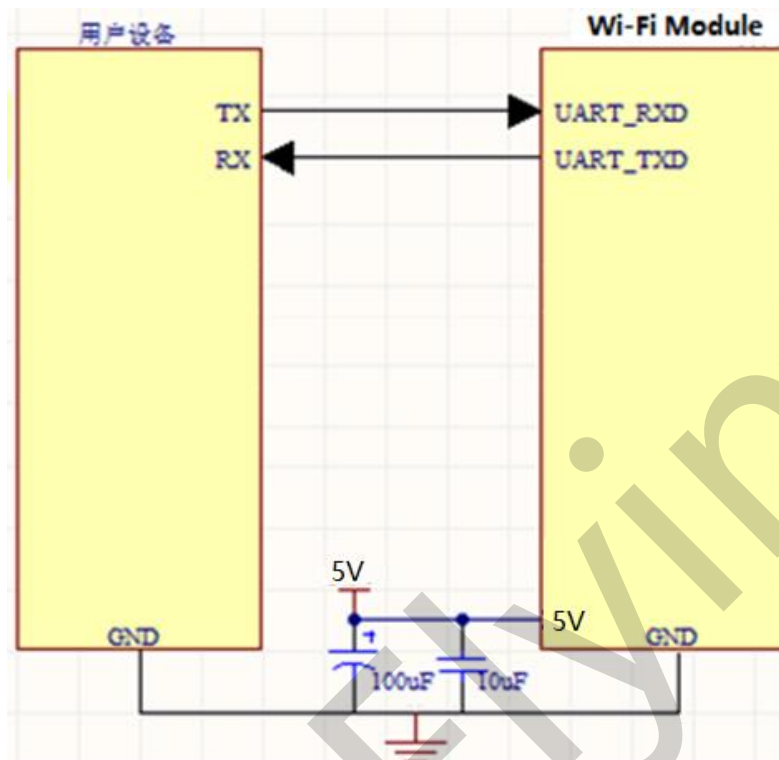

Figure 5. HF-LPB125 Hardware Typical Application

Notes:

nReset- Module hardware reset signal. Input. Logics “0” effective.

There is pull-up resistor internal and no external pull-up required. When module power up or some issue happened, MCU need assert nRST signal “0” at least 10ms, then set” 1” to keep module fully reset.

UART0_TXD/RXD- UART port data transmit and receive signal.

2. FUNCTIONAL DESCRIPTION

2.1. Wireless Networking

HF-LPB125 module can be configured as both wireless STA and AP base on network type. Logically there are two interfaces in HF-LPB125. One is for STA, and another is for AP. When HF-LPB125 works as AP, other STA equipments are able to connect to HF-LPB125 module directly. Wireless Networking with HF-LPB125 is very flexible.

Notes:

AP: that is the wireless Access Point, the founder of a wireless network and the centre of the network nodes. The wireless router we use at home or in office may be an AP.

STA: short for Station, each terminal connects to a wireless network (such as laptops, PDA and other networking devices) can be called with a STA device.

2.1.1. Basic Wireless Network Based On AP (Infrastructure)

Infrastructure: it's also called basic network. It built by AP and many STAs which join in. The characters of network of this type are that AP is the centre, and all communication between STAs is transmitted through the AP. The figure following shows such type of networking.

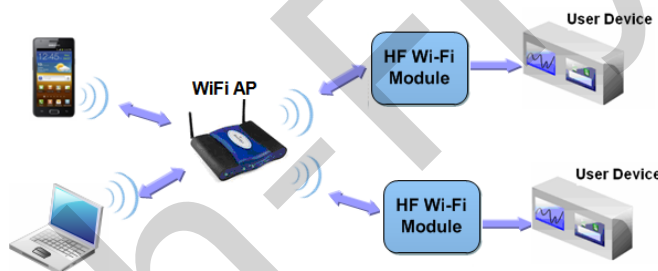

Figure 6. HF-LPB125 Basic Wireless Network Structure

2.1.2. Wireless Network Based On STA

HF-LPB125 module support STA network mode.

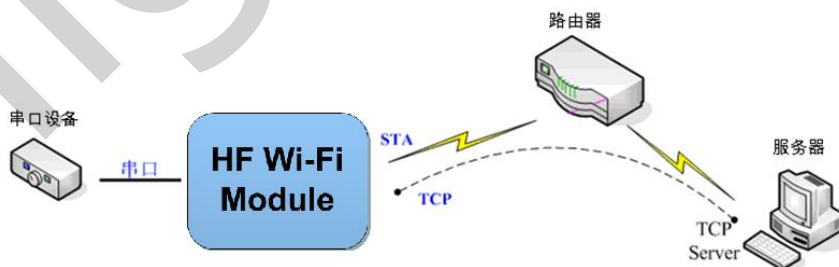

Figure 7. HF-LPB125 STA Network Structure

2.2. Work Mode : Transparent Transmission Mode

HF-LPB125 module support serial interface transparent transmission mode. The benefit of this mode is achieves a plug and play serial data port, and reduces user complexity furthest. In this mode, user should only configure the necessary parameters. After power on, module can automatically connect to the default wireless network and server.

As in this mode, the module's serial port always work in the transparent transmission mode, so users only need to think of it as a virtual serial cable, and send and receive data as using a simple serial. In other words, the serial cable of users' original serial devices is directly replaced with the module; user devices can be easy for wireless data transmission without any changes.

The transparent transmission mode can fully compatible with user's original software platform and reduce the software development effort for integrate wireless data transmission.

The parameters which need to configure include:

- **Wireless Network Parameters**
 - Wireless Network Name (SSID)
 - Security Mode
 - Encryption Key
- **TCP/UDP Linking Parameters**
 - Protocol Type
 - Link Type (Server or Client)
 - Target Port ID Number
 - Target Port IP Address
- **Serial Port Parameters**
 - Baud Rate
 - Data Bit
 - Parity (Check) Bit
 - Stop Bit
 - Hardware Flow Control

2.3. Encryption

Encryption is a method of scrambling a message that makes it unreadable to unwanted parties, adding a degree of secure communications. There are different protocols for providing encryption, and the HF-LPB125 module supports following:

- ◆ WEP
- ◆ WPA-PSK/TKIP
- ◆ WPA-PSK/AES
- ◆ WPA2-PSK/TKIP
- ◆ WPA2-PSK/AES

2.4. Parameters Configuration

HF-LPB125 module supports two methods to configuration parameters: **AT+instruction set**.

AT+instruction set configuration means user configure parameters through serial interface command. Refer to “AT+instruction set” chapter for more detail.

2.5. Firmware Update

HF-LPB125 module supports multiple upgrade methods:

- UART upgrade
- Local Network upgrade
- Remote upgrade

HF-LPB125 module support upgrade from remote HTTP server, keep module connects to AP router before excute remote HTTP upgrade.

Direct Download and Upgrade

AT+UPURL command to set the remote directory and file name, such as:

AT+UPURL=http://www.hi-flying.com/admin/down/lpb.bin

After excuate this command, the module will directly download the “lpb.bin” file from remote directory and start upgrade Application.

Notes: please contact with high-flying technical people before upgrade firmware, or maybe damage the module and can't work again.

2.6. SOCKET B Function

HF-LPB125 support double socket communication, the socket B function is disabled by default.

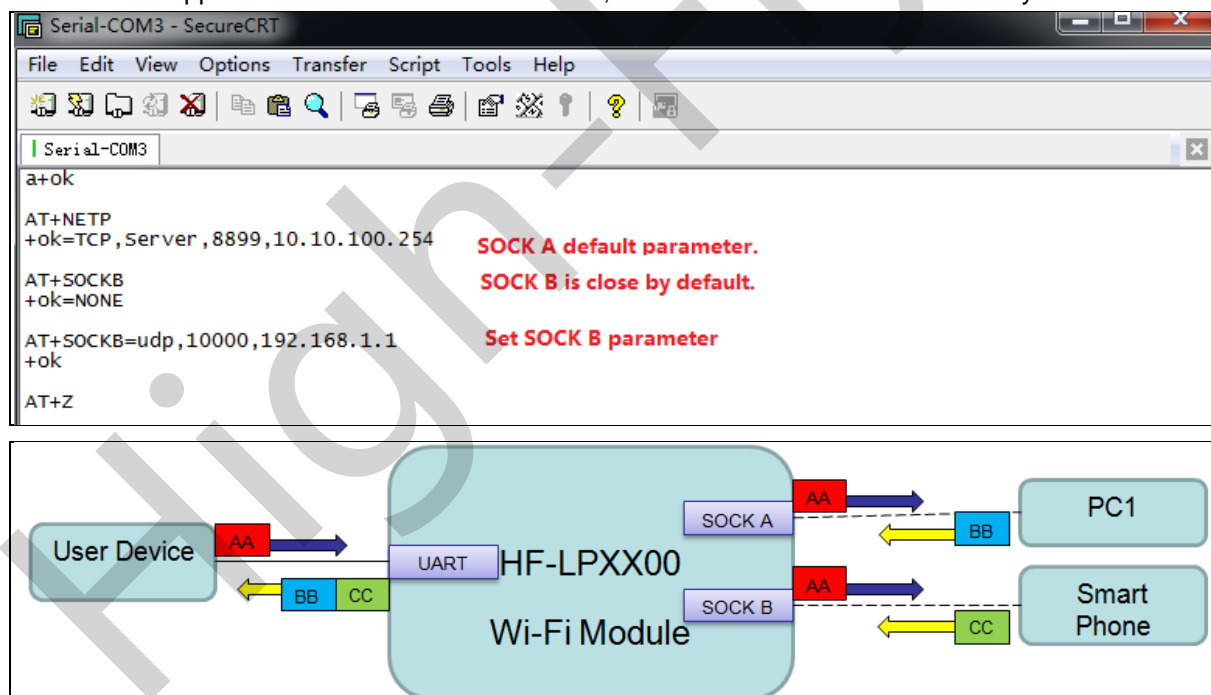

Figure 8. Socket B function demo

2.7. Multi-TCP Link Connection (Reserved)

When HF-LPB125 module SOCK A configured as TCP Server, it supports Multi-TCP link connection, and maximum 5 TCP clients permitted to connect to HF-LPB125 module. User can realize multi-TCP link connection at each work mode.

Multi-TCP link connection will work as following structure:

Upstream: All dates from different TCP connection or client will be transmitted to the serial port as a sequence.

Downstream: All data from serial port (user) will be replicate and broadcast to every TCP connection or client.

Detailed multi-TCP link data transmission structure as following figure:

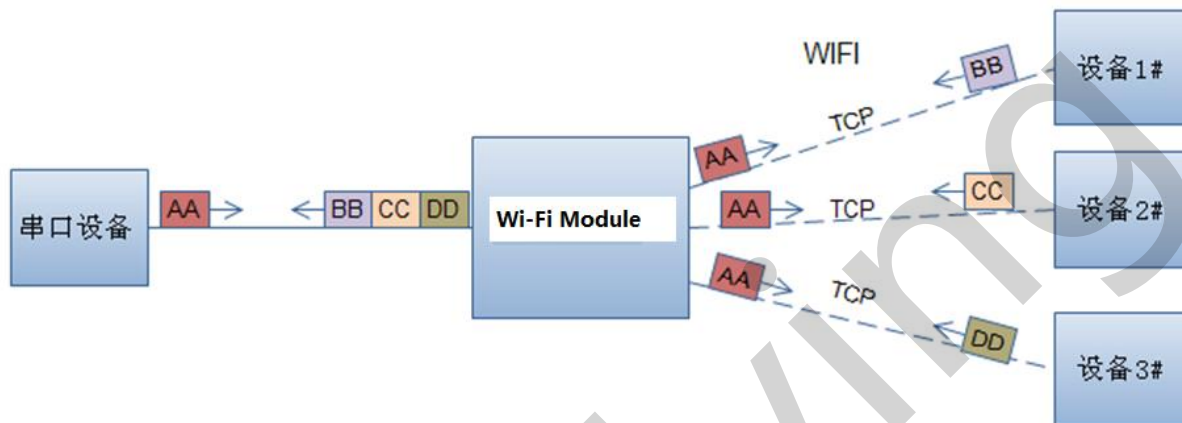

Figure 9. Multi-TCP Link Data Transmission Structure

3. OPERATION GUIDELINE

3.1. Configuration

When first use HF-LPB125 modules, user may need some configuration. User can connect to HF-LPB125 module’s wireless interface with following default setting information and configure the module through laptop.

Table6. HF-LPB125 Web Access Default Setting

Parameters	Default Setting
SSID	HF-LPB125
IP Address	10.10.100.254
Subnet Mask	255.255.255.0
Account	admin
Password	admin

3.1.1. Open Web Management Interface

There is internal webpage and external webpage in modules. The external webpage is for web management. The internal webpage is only for upgrading.

- Step 1: Connect laptop to SSID “HF-LPB125” of HF-LPB125 module via wireless LAN card;
- Step 2: After wireless connection OK. Open Wen browser and access “<http://10.10.100.254>”;
- Step 3: Then input user name and password in the page as following and click “OK” button.



Figure 10. Open Web Management page

The HF-LPB125 web management page support English and Chinese language. User can select language environment at the top right corner and click “Apply” button.

The main menu include nine pages: “System”, “Work Mode”, “STA Setting”, “AP Setting”, “Other Setting”, “Account”, “Upgrade SW”, “Restart”, “Restore”.

Note: [Webpage function is 2.0.09-6 firmware new added.](#), so the previous software version does not support webpage, but after upgrade to our latest, it can support this, see appendix latest firmware on

our website. For current module, we may not ship it with default webpage support, please manual upgrade if need to use this function or tell our sales to upgrade to this latest function before shipment.

3.1.2. System Page

At this page, user can check current device's important information and status such as: device ID (MID), software version, wireless work mode and related Wi-Fi parameters.

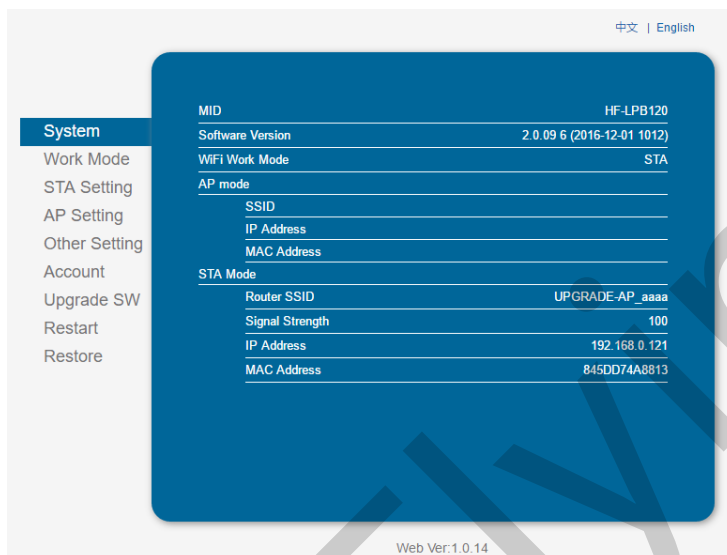

Figure 11. System Web Page

3.1.3. Work Mode Page

HF-LPB125 module can works at AP mode to simplify user's configuration, can also works at STA to connect remote server through AP router.



Figure 12. Work Mode Page

3.1.4. STA Setting Page

User can push “Scan” button to auto search Wi-Fi AP router nearby, and can connect with associate AP through some settings. Please note the encryption information input here must be fully same with Wi-Fi AP router’s configuration, and then it can link with AP correctly.

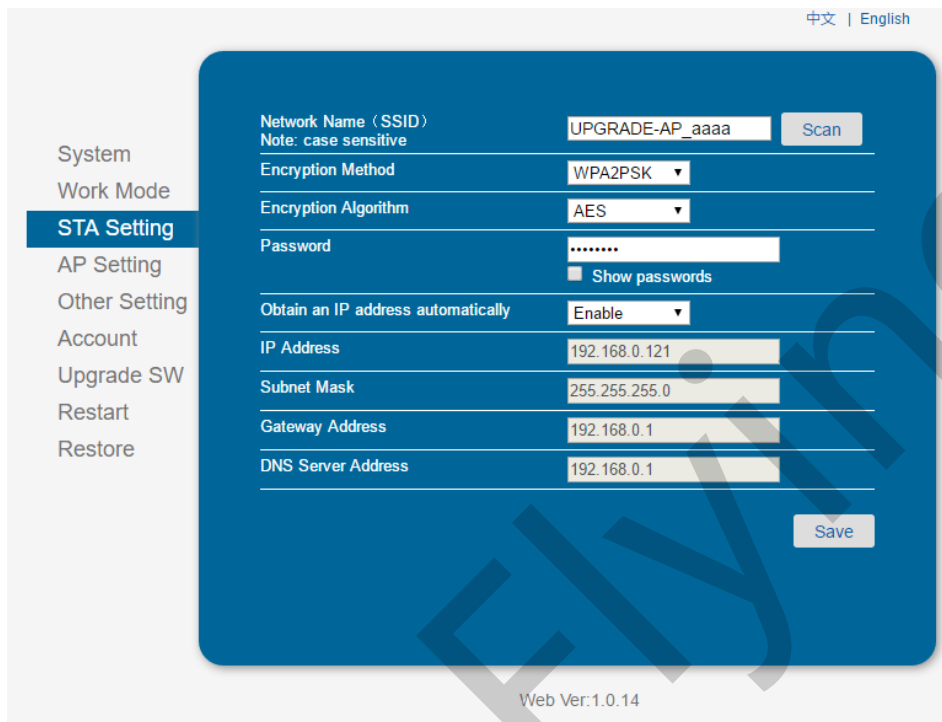

Figure 13. STA Setting Page

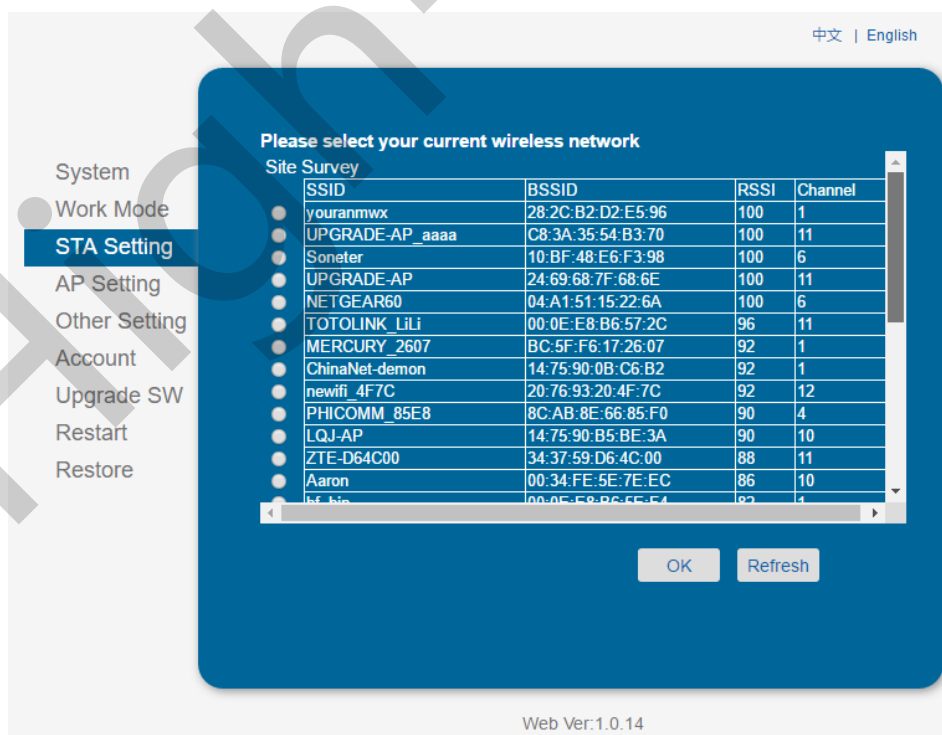

Figure 14. STA Scan Page

3.1.5. AP Setting Page

When user select module works at AP and AP+STA mode, then need setting this page and provide wireless and network parameters. Most of the system support DHCP to achieve IP address, so we suggest to “Enable” DHCP server in most applications.

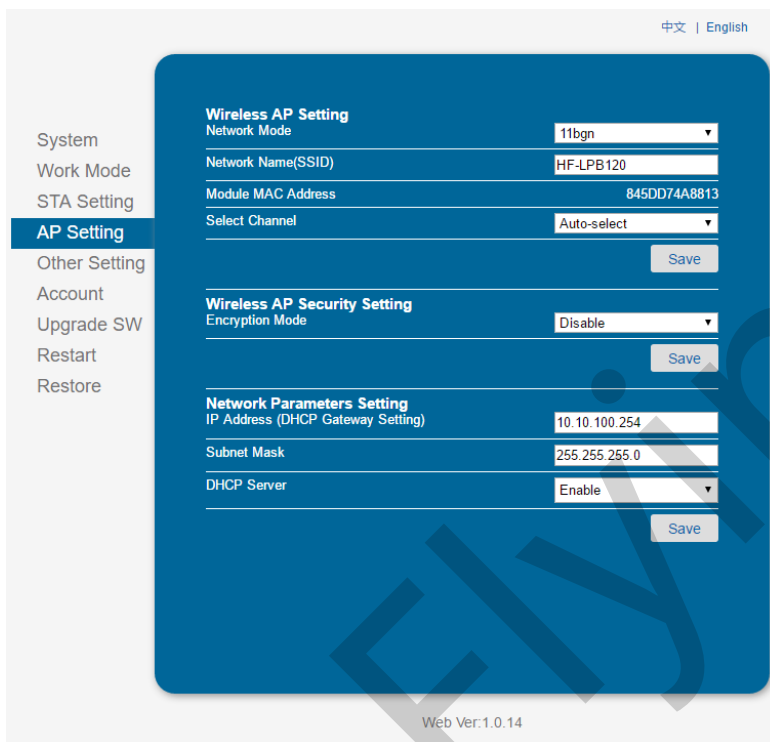

Figure 15. AP Setting Page

3.1.6. Other Setting Page

HF-LPB125 usually works at data transparent transmission mode. At this mode, the user device which connected with HF-LPB125 will connect and communicate with remote PC or server. At this page, user need setting serial port communication parameters and defines TCP related protocol parameters.

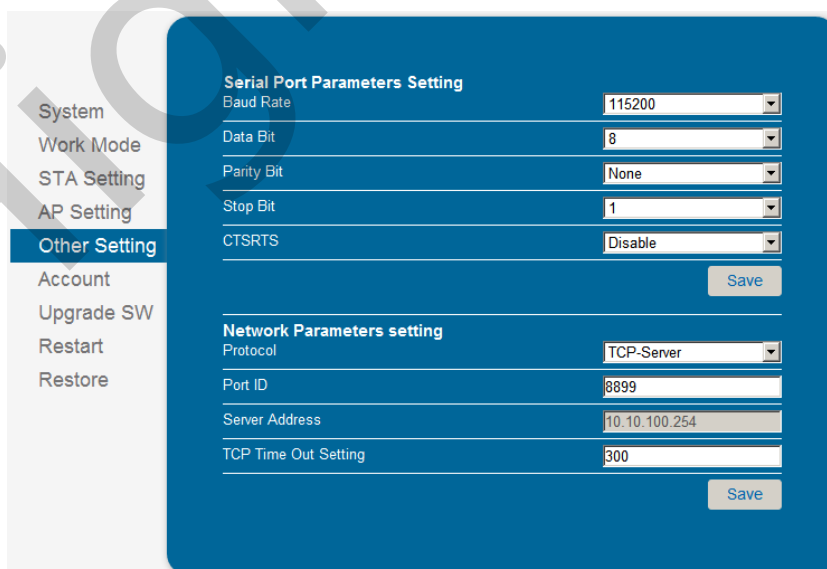

Figure 16. Other Setting Page

3.1.7. Account Management Page

This page set web server's user name and password.

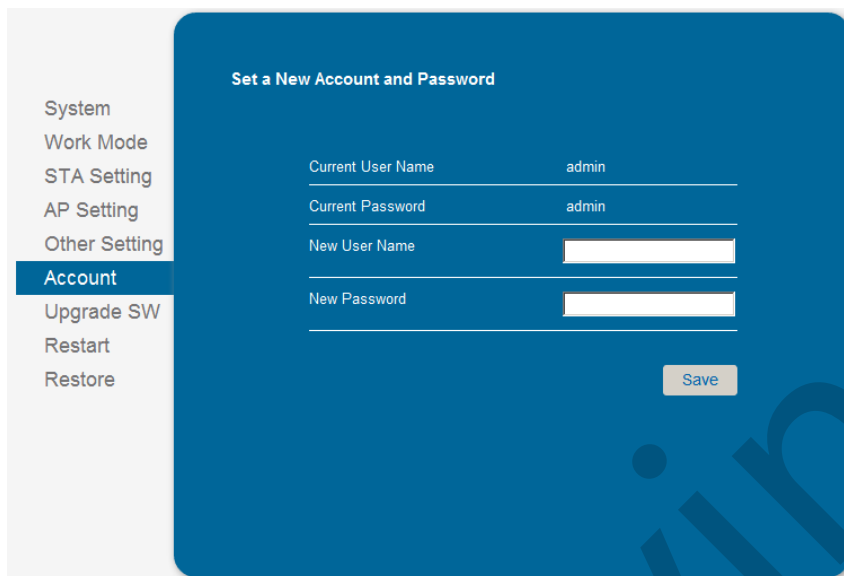

Figure 17. Account Page

3.1.8. Upgrade Software Page

User can upgrade new software (firmware) version through Wi-Fi. After upgrade success, need reboot it manually before new firmware valid.

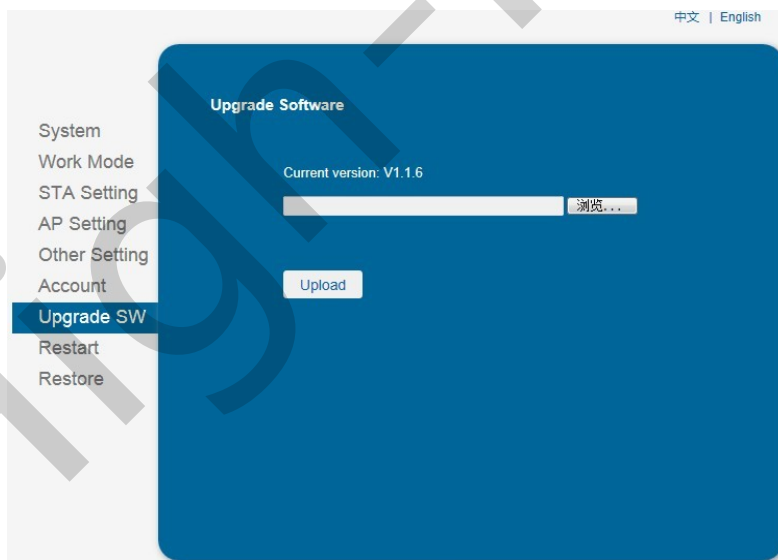

Figure 18. Upgrade SW page

3.1.9. Restart Page

Most of the setting and configuration can only effective after system restart. User shall restart after finish all setting.

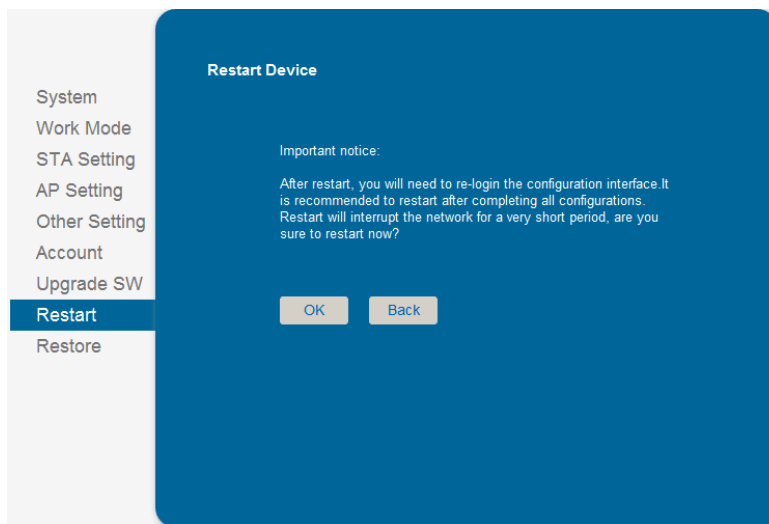

Figure 19. Restart Page

3.1.10. Restore Page

After module restore factory default setting, all user configuration profile will lose.

User can access <http://10.10.100.254> to set again, and user name and password is “admin”. HF-LPB125 will restore to AP mode for factory default setting.

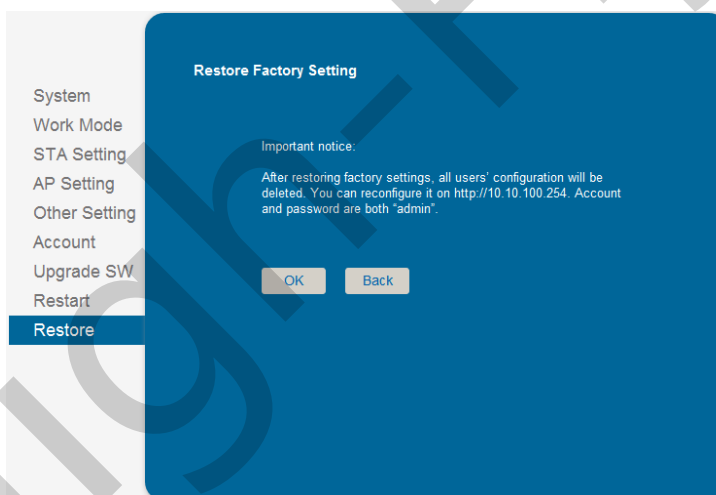

Figure 20. Restore Page

3.1.11. Internal Webpage

After wireless connection is OK. Open Wen browser and access “<http://10.10.100.254/iweb.html>”; It is for upgrading application and external webpage. After upgrade success, need reboot it manually before new firmware or webpage valid.





Figure 21. Internal Webpage

3.2. Usage Introduction

3.2.1. Software Debug Tools

High-Flying use two common software tools debugging and applying HF-LPB125 module. (User can also select other tools used to debug serial port).

- Serial Debugging Software: ComTools  ComTools.exe
- Ethernet Debugging Software: TCPUDPDbg  TCPUDPDbg.exe

3.2.2. Network Connection

User can select two methods to connect HF-LPB125 module base on dedicated application.

- **Use HF-LPB125 STA interface.** HF-LPB125 and debug PC2 connect to a wireless AP, another PC1 (or user device) connect to HF-LPB125 module with serial port:



Figure 22. STA Interface Debug Connection

- **Use HF-LPB125 AP interface.** Debug PC2 connect to HF-LPB125 through wireless connection, another PC1 (or user device) connect to HF-LPB125 module with serial port.



Figure 23. AP Interface Debug Connection

3.2.3. Default Parameter Setting

- Default SSID: HF-LPB125;
- Deault security mode: open,none;

- User UART parameter setting:115200,8,1,None;
- Default network parameter setting:TCP,Server,8899,10.10.100.254;
- Module IP address: dhcp,0.0.0.0,0.0.0.0,0.0.0.0;

3.2.4. Module Debug

PC1 open “CommTools” program, setting the same serial port parameters with HF-LPB125 module and open serial port connection.

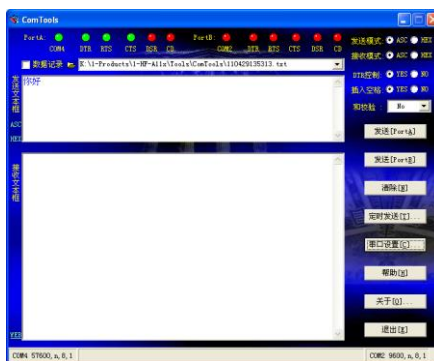

Figure 24. “CommTools” Serial Debug Tools

PC2 open “TCPUDPDbg” program, and create a new connection. If HF-LPB125 configured as Server mode, “TCPUDPDbg” Tools shall create “Client” mode connection. Or otherwise, create a “Server” mode connection.

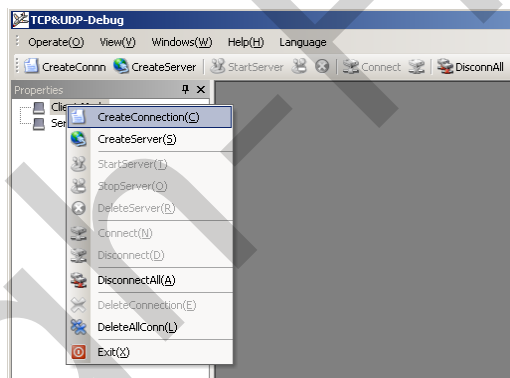

Figure 25. “TCPUDPDbg” Tools Create Connection

Then setting the TCP/UDP connection parameters. Default as following:

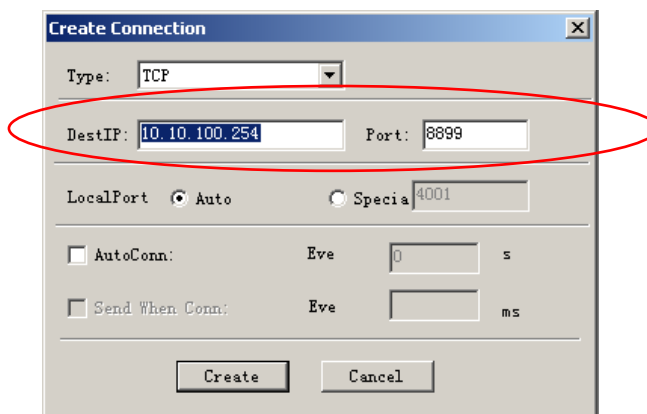

Figure 26. “TCPUDPDbg” Tools Setting

Then, click “Create” button to create a connection.

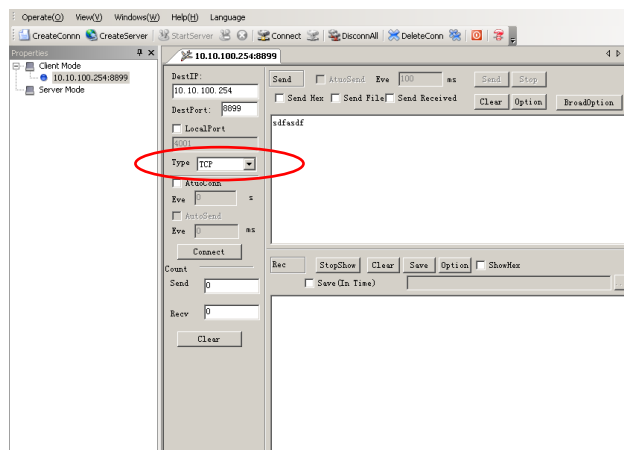

Figure 27. “TCPUDPDbg” Tools Connection

Now, in transparent transmission mode, data can be transferred from “CommTools” program to “TCPUDPDbg” program, or in reverse. You can see data in receiver side will keep same as in sender side.

3.3. Typical Application Examples

3.3.1. Wireless Control Application



Figure 28. Wireless Control Application

For this wireless control application, HF-LPB125 works as AP mode. Module’s serial port connects to user device. So, control agent (Smart phone for this example) can manage and control the user device through the wireless connection with HF-LPB125 module.

3.3.2. Remote Management Application

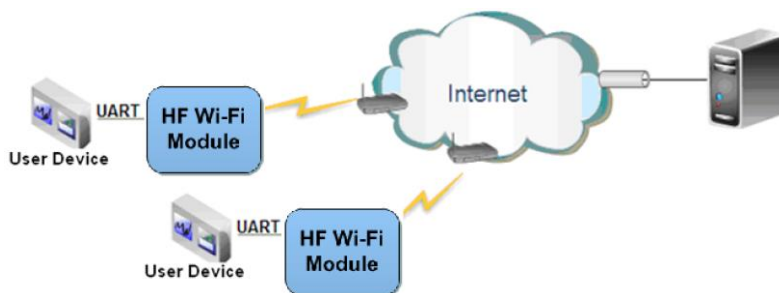

Figure 29. Remote Management Application

For this remote management application, HF-LPB125 works as STA mode and connects to Internet through wireless AP. Module configured as TCP Client and communicates with remote TCP server at Internet. Module's serial port connects to user device.

So, user device's data or sampling information can send to remote TCP server for storage or processing. Also remote TCP server can send command to control and manage the user device through the wireless network.

3.3.3. Transparent Serial Port Application

For this transparent serial port application, two HF-LPB125 modules connect as below figures to build up a transparent serial port connection. One HF-LPB125 works as AP mode, another HF-LPB125 works as STA mode. Make the STA device connects to AP.



Figure 30. Transparent Serial Port Application

4. AT+INSTRUCTION INTRODUCTION

4.1. Configuration Mode

When HF-LPB125 power up, it will default works as transparent transmission mode, then user can switch to configuration mode by serial port command. HF-LPB125 UART default parameters setting as below figure,

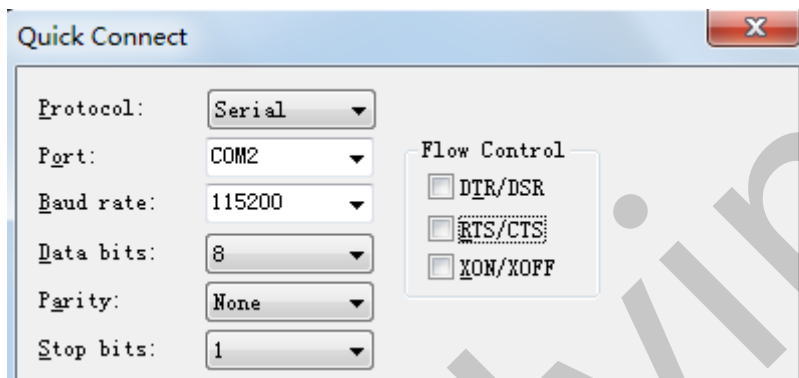

Figure 31. HF-LPB125 Default UART Port Parameters

In configuration mode, user can setting the module through AT+instruction set, which cover all web page setting function.

4.1.1. Switch to Configuration Mode

Two steps to finish switching from transparent transmission mode to configuration mode.

- **UART input “+++”, after module receive “+++”, and feedback “a” as confirmation.**
- **UART input “a”, after module receive “a” and feedback “+ok” to go into AT+instruction set configuration mode.**

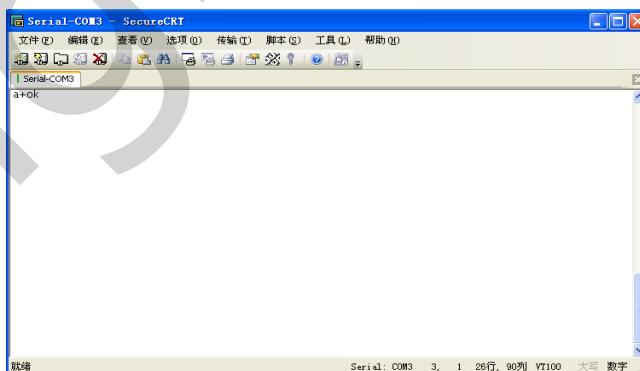
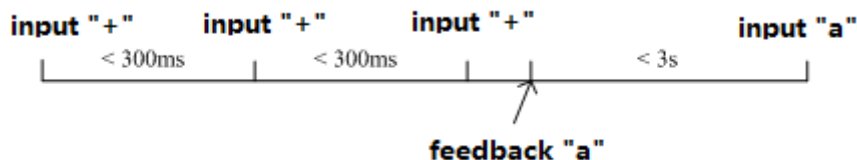

Figure 32. Switch to Configuration Mode

Notes:

1. When user input “+++” (No “Enter” key required), the UART port will display feedback information “a”, and not display input information”+++” as above UART display.

2. Any other input or wrong step to UART port will cause the module still works as original mode (transparent transmission).
3. “+++” and “a” should be input in a certain period of time to make the module switch to configuration mode. Like the following sequence.



4.2. AT+Instruction Set Overview

User can input AT+Instruction through hyper terminal or other serial debug terminal, also can program the AT+Instruction to script. User can also input “AT+H” to list all AT+Instruction and description to start.

```

AT+H
+ok

AT+: NONE command, reply "+ok".
AT+ASWD: Set/Query WiFi configuration code.
AT+E: Echo ON/Off, to turn on/off command line echo function.
AT+ENTM: Goto Through Mode.
AT+NETP: Set/Get the Net Protocol Parameters.
AT+UART: Set/Get the UART Parameters.
AT+UARTF: Enable/disable UART AutoFrame function.
AT+UARTFT: Set/Get time of UART AutoFrame.
AT+UARTFL: Set/Get frame length of UART AutoFrame.
AT+UARTTE: Set/Query UART free-frame triggerf time between two byte.
AT+PING: General PING command.
AT+WAP: Set/Get the AP parameters.
AT+WAKEY: Set/Get the Security Parameters of WIFI AP Mode.
AT+WMODE: Set/Get the WIFI Operation Mode (AP or STA).
AT+WSKEY: Set/Get the Security Parameters of WIFI STA Mode.
AT+WSSSID: Set/Get the AP's SSID of WIFI STA Mode.
AT+WSLK: Get Link Status of the Module (only for STA Mode).
AT+WSQLQ: Get Link Quality of the Module (only for STA Mode).
AT+WSCAN: Get The AP site Survey (only for STA Mode).
AT+WEBU: Set/Get the Login Parameters of WEB page.
AT+TCPK: Get The state of TCP link.
AT+TCPPTO: Set/Get TCP time out.
AT+TCPDIS: Connect/Dis-connect the TCP Client link
AT+RECV: Recv data from UART
AT+SEND: Send data to UART
AT+WANN: Set/Get The WAN setting if in STA mode.
AT+LANN: Set/Get The LAN setting if in ADHOC mode.
AT+RELD: Reload the default setting and reboot.
AT+RLDEN: Put on/off the GPIO12.
AT+Z: Reset the Module.
AT+MID: Get The Module ID.
AT+VER: Get application version.
AT+H: Help.
    
```

Figure 33. "AT+H" Instruction for Help

4.2.1. Instruction Syntax Format

AT+Instruction protocol is based on the instruction of ASCII command style, the description of syntax format as follow.

- **Format Description**
 - <>: Means the parts must be included
 - [: Means the optional part
- **Command Message**

AT+<CMD>[op][para-1,para-2,para-3,para-4...]<CR>

- AT+: Prefix of command message;
- CMD: Command string;
- [op]: Symbol of command operator,
 - ◆ “=” : The command requires parameters input;
 - ◆ “NULL”: Query the current command parameters setting;
- [para-n]: Parameters input for setting if required;
- <CR>: “Enter” Key, it’s 0x0a or 0x0d in ASCII;

Notes: When input AT+Instruction, “AT+<CMD>” character will display capital letter automatic and other parts will not change as you input.

➤ **Response Message**

+<RSP>[op] [para-1,para-2,para-3,para-4...]<CR><LF><CR><LF>

- +: Prefix of response message;
- RSP: Response string;
 - ◆ “ok” : Success
 - ◆ “ERR”: Failure
- [op] : =
- [para-n]: Parameters if query command or Error code when error happened;
- <CR>: ASCII 0x0d;
- <LF>: ASCII 0x0a;

➤ **Error Code**

Table7. Error Code Description

Error Code	Description
-1	Invalid Command Format
-2	Invalid Command
-3	Invalid Operation Symbol
-4	Invalid Parameter
-5	Operation Not Permitted

4.2.2. AT+Instruction Set

Table8. AT+Instruction Set List

Instruction	Description
<null>	NULL
Management Instruction Set	
E	Open/Close show back function
WMODE	Set/Query Wi-Fi work mode (AP/STA)
ENTM	Set module into transparent transition mode
MID	Query module ID information

Instruction	Description
VER	Query module software version information
BVER	Query module bootloader version
RELD	Restore to factory default setting
FCLR	Erase factory setting
Z	Re-start module
H	Help
Configure Parameters Instruction Set	
CFGTF	Copy User Parameters to Factory Default Parameters
UART Instruction Set	
UART	Set/Query serial port parameters
Network Instruction Set	
NETP	Set/Query network protocol parameters
MAXSK	Set/Query TCP Client connection number
TCPLK	Query if TCP link already build-up
TCPTO	Set/Query TCP timeout
TCPDIS	Open/Close TCP link
SOCKB	Set/Query SOCKB parameters
TCPDISB	Open/Close SOCKB TCP link
TCPTOB	Set/Query SOCKB TCP timeout
TCPLKB	Query if SOCKB TCP link already build-up
Wi-Fi STA Instruction Set (Effective when module works as STA)	
WSKEY	Set/Query STA security parameters
WSSID	Set/Query associated AP SSID parameters
WANN	Set/Query STA's network parameters
WSMAC	Set/Query module MAC address
WSLK	Query STA Wi-Fi link status
WSLQ	Query STA Wi-Fi signal strength
WSCAN	Scan AP
Wi-Fi AP Instruction Set (Effective when module works as AP)	
LANN	Set/Query AP's network parameters
WAP	Set/Query AP Wi-Fi parameters
WAKEY	Set/Query AP security parameters
WADHCP	Set/Query AP DHCP Server status
WALK	Query MAC address of STA device connecting to module AP
WALKIND	Enable/Disable indication of connection status.
WAPMXSTA	Set/Query max STA devices supported for AP.
Remote Upgrade Instruction Set	
OTA	Upgrade Firmware
UPURL	Set/Query remote upgrade URL address
Power Management Instruction Set	
DISPS	Set/Query power save parameters
Webpage Set	
PLANG	Set/Query webpage language
WEBU	Set/Query webpage login account
Others Instruction Set	
WRMID	Set module ID
ASWD	Set/Query WiFi configuration code
SMTLK	Start SmartLink function
SMEM	Query RAM status
NDBG	Set UART debug information

4.2.2.1. AT+E

- Function: Open/Close show back function;
- Format:

- ◆ Set Operation

AT+E=<status><CR>

+ok<CR><LF><CR><LF>

- Parameters:

- ◆ status: Echo status
 - ◇ on: Open echo
 - ◇ off: Close echo

When HF-LPB125 module firstly switch from transparent transmission to configuration mode, show back status is open, input "AT+E" to close show back function, input "AT+E" again to open show back function, use AT+E=on/off command to save the echo status..

4.2.2.2. AT+WMODE

- Function: Set/Query Wi-Fi work mode. Setting is valid after reset;
- Format:

- ◆ Query Operation

AT+WMODE<CR>

+ok=<mode><CR><LF><CR><LF>

- ◆ Set Operation

AT+WMODE=<mode><CR>

+ok<CR><LF><CR><LF>

- Parameters:

- ◆ mode:Wi-Fi work mode
 - ◇ AP
 - ◇ STA

4.2.2.3. AT+ENTM

- Function: Set module into transparent transmission mode;
- Format:

AT+ENTM<CR>

+ok<CR><LF><CR><LF>

When operate this command, module switch from configuration mode to transparent transmission mode.

4.2.2.4. AT+MID

- Function: Query module ID information;
- Format:

- ◆ Query Operation

AT+MID<CR>

+ok=<module_id><CR><LF><CR><LF>

- Parameters:

- ◆ module_id: Module ID information;

✧ HF-LPB125;

Notes: User can set this parameter through AT+WRMID.

4.2.2.5. AT+VER

- Function: Query module software version information;
 - Format:
 - ◆ Query Operation
- ```
AT+VER<CR>
```
- ```
+ok=<ver><CR><LF><CR><LF>
```
- Parameters:
 - ◆ ver: Module software version information;

4.2.2.6. AT+BVER

- Function: Query module bootloader software version information
 - Format:
 - ◆ Query Operation
- ```
AT+LVER<CR>
```
- ```
+ok=<ver><CR><LF><CR><LF>
```
- Parameters:
 - ◆ ver: Module bootloader version information;

Bootloader is for module upgrade firmware via UART. See details on our website about the module firmware download page.

4.2.2.7. AT+RELD

- Function: module restore to factory default setting;
 - Format:
 - ◆ Set Operation
- ```
AT+RELD<CR>
```
- ```
+ok=rebooting...<CR><LF><CR><LF>
```

When operate this command, module will restore to factory default setting and reboot.

4.2.2.8. AT+FCLR

- Function: Erase factory setting;
 - Format:
 - ◆ Query Operation
- ```
AT+FCLR<CR>
```
- ```
+ok=<status><CR><LF><CR><LF>
```

4.2.2.9. AT+Z

- Function: Re-start module;
- Format:

```
AT+Z<CR>
```

4.2.2.10. AT+H

- Function: Help;

- Format:
 - ◆ Query Operation
- AT+H<CR>**
- +ok=<command help><CR><LF><CR><LF>**
- Parameters:
 - ◆ command help: command introduction;

4.2.2.11. AT+CFGTF

- Function: Copy User Parameters to Factory Default Parameters;
 - Format:
 - ◆ Query Operation
- AT+CFGTF<CR>**
- +ok=<status><CR><LF><CR><LF>**
- Parameters:
 - ◆ status: feedback operation status;

4.2.2.12. AT+UART

- Function: Set/Query serial port parameters. Setting is valid after reset.
 - Format:
 - ◆ Query Operation
- AT+UART[=uart_num]<CR>**
- +ok=<baudrate,data_bits,stop_bit,parity,flowctrl><CR><LF><CR><LF>**
- ◆ Set Operation
- AT+UART=<baudrate,data_bits,stop_bit,parity,flowctrl>[,uart_num]<CR>**
- +ok<CR><LF><CR><LF>**
- Parameters:
 - ◆ uart_num: UART Channel, the default is UART0.
 - 0: UART0 Channel
 - ◆ baudrate:
 - ◇ 1200,1800,2400,4800,9600,19200,38400,57600,115200,230400,380400,460800,921600
 - ◆ data_bits:
 - ◇ 8
 - ◆ stop_bits:
 - ◇ 1,2
 - ◆ parity:
 - ◇ NONE
 - ◇ EVEN
 - ◇ ODD
 - ◆ Flowctrl: (CTSRTS),
 - ◇ NFC: No hardware flow control
 - ◇ **FC: hardware flow control(Not supported)**

4.2.2.13. AT+NETP

- Function: Set/Query network protocol parameters, Setting is valid after reset.

- Format:

- ◆ Query Operation

AT+NETP<CR>

+ok=<protocol,CS,port,IP><CR><LF><CR><LF>

- ◆ Set Operation

AT+NETP=<protocol,CS,port,IP><CR>

+ok<CR><LF><CR><LF>

- Parameters:

- ◆ protocol:

- ◇ TCP

- ◇ UDP

- ◆ CS: Network mode:

- ◇ SERVER

- ◇ CLIENT

- ◆ Port: protocol port ID: Decimal digit and less than 65535

- ◆ IP: Server's IP address when module set as client

If set as UDP SERVER, the module will save the IP address and port of the latest UDP packet received. The data will be sent to the saved IP address and port. If the module hasn't saved any IP address and port when power up. The data will be sent to the IP address and port which is set by this command.

If set as UDP,CLIENT, the data will always be sent to the IP address and port set by this command.

4.2.2.14. AT+MAXSK

- Function: Set/ Query TCP Client connection number.

- Format:

- ◆ Query Operation

AT+MAXSK<CR>

+ok=<num><CR><LF><CR><LF>

- ◆ Set Operation

AT+MAXSK=<num><CR>

+ok<CR><LF><CR><LF>

- Parameters:

- ◆ num: TCP Client connection number. Range: 1~5. 5 is the default value it means when the module work in TCP server , it accepts max 5 TCP client connect to it.

4.2.2.15. AT+TCPLK

- Function: Query if TCP link already build-up;

- Format:

AT+TCPLK<CR>

+ok=<sta><CR><LF><CR><LF>

- Parameters:

- ◆ sta.: if module already setup TCP link;
 - ◇ on: TCP link setup;
 - ◇ off: TCP link not setup;

4.2.2.16. AT+TCPTO

- Function: Set/Query TCP timeout; Setting is valid after reset.

- Format:

- ◆ Query Operation

AT+TCPTO<CR>

+ok=<time><CR><LF><CR><LF>

- ◆ Set Operation

AT+TCPTO=<time ><CR>

+ok<CR><LF><CR><LF>

- Parameters:

- ◆ time: TCP timeout time.

- ◇ ≤ 600, (600s);
- ◇ ≥ 0, (0 means no timeout);
- ◇ Default, 300s;

Module begin to count time when TCP channel don't receive any data, clecherar time counter when TCP channel receive any data. If the time counter reaches the TCPTO, the tcp channel will be break. If the module work in TCP Client, it will connect the TCP server instantly and when the module work in TCP Server, the TCP client device should make the connection itself.

4.2.2.17. AT+TCPDIS

- Function: Open/Close TCP link;

- Format:

- ◆ Query Opera

AT+TCPDIS<CR>

+ok=<sta><CR><LF><CR><LF>

- ◆ Set Operation

AT+TCPDIS =<on/off><CR>

+ok<CR><LF><CR><LF>

- Parameters:

When query, sta.: Feedback if TCP Client can be link,

- ◇ On, TCP link close
- ◇ off, TCP link on

When setting, "off" means close TCP link. After finish this command, module disconnect TCP link and not connect again. "On" means open TCP link. After finish this command, module re-connect TCP server right away.

4.2.2.18. AT+SOCKB

- Function: Set/Query SOCKB parameters. Setting is valid after reset.

- Format:

◆ Query Operation

AT+SOCKB<CR>

+ok=<protocol,port,IP><CR><LF><CR><LF>

◆ Set Operation

AT+SOCKB=<protocol,port,IP><CR>

+ok<CR><LF><CR><LF>

■ Parameters:

◆ Protocol: Protocol type:

- ◇ TCP: Only for TCP Client
- ◇ UDP: UDP Client
- ◇ UDPS: UDP Server

◆ Port: Protocol Port in decimal, less than 65535

◆ IP: Destination IP address, domain name is support

If set as UDP SERVER, the module will save the IP address and port of the latest UDP packet received. The data will be sent to the saved IP address and port. If the module hasn't saved any IP address and port when power up. The data will be sent to the IP address and port which is set by this command.

If set as UDP,CLIENT, the data will always be sent to the IP address and port set by this command.

4.2.2.19. AT+TCPDISB

■ Function: Open/Close SOCKB connection

■ Format:

◆ Query Operation

AT+TCPDISB<CR>

+ok=<sta><CR><LF><CR><LF>

◆ Set Operation

AT+TCPDISB =<on/off><CR>

+ok<CR><LF><CR><LF>

■ Parameters:

When setting, "off" means close TCP link. After finish this command, module disconnect TCP link and not connect again. "On" means open TCP link. After finish this command, module re-connect TCP server right away.

4.2.2.20. AT+TCPTOB

■ Function: Set/Query Operation SOCKB TCP timeout. Setting is valid after reset.

■ Format:

◆ Query Operation

AT+TCPTOB<CR>

+ok=<time><CR><LF><CR><LF>

◆ Set Operation

AT+TCPTOB=<time ><CR>

+ok<CR><LF><CR><LF>

■ Parameters

- ◆ Time: TCP timeout
 - ◇ ≤ 600:600s
 - ◇ ≥ 0:0 means no timeout
 - ◇ Default:300s

If the SOCKB TCP don't receive any data from TCP server for TCP tmeout setting, the module will break and reconnect the TCP server. If it receive data from server, the timeout counter will be clear.

4.2.2.21. AT+TCPLKB

- Function:Query SOCKB connection status
- Format:

AT+TCPLKB<CR>

+ok=<sta><CR><LF><CR><LF>

- Parameters:
 - ◆ sta.: SOCKB connection status
 - ◇ on: TCP connected
 - ◇ off: TCP disconnected

4.2.2.22. AT+WSSSID

- Function: Set/Query Wi-Fi associated AP SSID parameters. Setting is valid after reset.
- Format:

- ◆ Query Operation

AT+WSSSID<CR>

+ok=<ap's ssid><CR><LF><CR><LF>

- ◆ Set Operation

AT+WSSSID=<ap's ssid ><CR>

+ok<CR><LF><CR><LF>

- Parameters:
 - ◆ ap's ssid: AP's SSID (Within 32 character);

4.2.2.23. AT+WSKEY

- Function: Set/Query STA security parameters. Setting is valid after reset.
- Format:

- ◆ Query Operation

AT+WSKEY<CR>

+ok=<auth,encry,key><CR><LF><CR><LF>

- ◆ Set Operation

AT+WSKEY=< auth,encry,key><CR>

+ok<CR><LF><CR><LF>

- Parameters:
 - ◆ auth: Authentication mode
 - ◇ OPEN
 - ◇ SHARED
 - ◇ WPAPSK

- ◇ WPA2PSK
- ◆ encry: Encryption algorithm
 - ◇ NONE: When “auth=OPEN”, effective
 - ◇ WEP-H: When “auth=OPEN” or “SHARED”, effective, in HEX format
 - ◇ WEP-A: When “auth=OPEN” or “SHARED”, effective, in ASCII format
 - ◇ TKIP: When “auth= WPAPSK” or “WPA2PSK”, effective
 - ◇ AES: When “auth= WPAPSK” “WPA2PSK”, effective
- ◆ key: password. When encry is WEP-H, password is in HEX format, password length is 10 or 26. When encry is WEP-A, password is in ASCII format, password length is 5 or 13. When encry is TKIP or AES, password is in ASCII code, password length shall be less than 64 and greater than 8.

4.2.2.24. AT+WANN

- Function: Set/Query STA network setting. Setting is valid after reset.

- Format:

- ◆ Query Operation

AT+WANN<CR>

+ok=<mode,address,mask,gateway><CR><LF><CR><LF>

- ◆ Set Operation

AT+WANN=< mode,address,mask,gateway ><CR>

+ok<CR><LF><CR><LF>

- Parameters:

- ◆ mode: STA's IP network setting
 - ◇ static: Static IP
 - ◇ DHCP: Dynamic IP
- ◆ address: STA IP address;
- ◆ mask: STA subnet mask;
- ◆ gateway: STA gateway address;

4.2.2.25. AT+WSMAC

- Function: Set/Query Module MAC address parameters. Setting is valid after reset.

- Format:

- ◆ Query Operation

AT+WSMAC<CR>

+ok=<mac_address><CR><LF><CR><LF>

- ◆ Set Operation

AT+WSMAC=<code,mac_address><CR>

+ok<CR><LF><CR><LF>

- Parameters:

- ◆ code: security code
 - ◇ 8888 (default value)
- ◆ Mac_address: module MAC address, such as ACCF23FF1234

4.2.2.26. AT+WSLK

- Function: Query STA WiFi link status
 - Format:
 - ◆ Query Operation
- AT+WSLK<CR>**
+ok=<ret><CR><LF><CR><LF>
- Parameters:
 - ◆ ret
 - ◇ "Disconnected", if no WiFi connection;
 - ◇ "AP' SSID (AP's MAC") , if WiFi connection available;

4.2.2.27. AT+WSQL

- Function: Query STA WiFi signal strength;
 - Format:
 - ◆ Query Operation
- AT+WSQL<CR>**
+ok=<ret><CR><LF><CR><LF>
- Parameters:
 - ◆ ret
 - ◇ "Disconnected", if no WiFi connection;
 - ◇ "AP's WiFi signal strength" , if WiFi connection available;

4.2.2.28. AT+WSCAN

- Function: Scan AP;
 - Format:
 - ◆ Query Operation
- AT+WSCAN<CR>**
+ok=<ap_site><CR><LF><CR><LF>
- Parameters:
 - ◆ ap_site: AP searched;

4.2.2.29. AT+LANN

- Function: Set/Query AP's network parameters. Setting is valid after reset.
 - Format:
 - ◆ Query Operation
- AT+LANN<CR>**
+ok=<ipaddress,mask><CR><LF><CR><LF>
- ◆ Set Operation
- AT+LANN=< ipaddress,mask><CR>**
+ok<CR><LF><CR><LF>
- Parameters:
 - ◆ ipaddress: AP's IP address;
 - ◆ mask: AP's net mask;

4.2.2.30. AT+WAP

- Function: Set/Query AP Wi-Fi parameters. Setting is valid after reset.

- Format:

- ◆ Query Operation

AT+WAP<CR>

+ok=<wifi_mode,ssid,channel><CR><LF><CR><LF>

- ◆ Set Operation

AT+WAP =<wifi_mode,ssid,channel><CR>

+ok<CR><LF><CR><LF>

- Parameters:

- ◆ wifi_mode: Wi-Fi mode, include:

- ◇ 11B
- ◇ 11BG
- ◇ 11BGN (Default Value)

- ◆ ssid:SSID at AP mode, the maximum length is 32.

- ◆ channel: Wi-Fi channel selection:

- ◇ AUTO;(Default CH1)
- ◇ CH1~CH11;

4.2.2.31. AT+WAKEY

- Function: Set/Query AP Wi-Fi security parameters. Setting is valid after reset.

- Format:

- ◆ Query Operation

AT+WAKEY<CR>

+ok=<auth,encry,key><CR><LF><CR><LF>

- ◆ Set Operation

AT+WAKEY=< auth,encry,key><CR>

+ok<CR><LF><CR><LF>

- Parameters:

- ◆ auth: include

- ◇ OPEN
- ◇ WPA2PSK

- ◆ Encry: include

- ◇ NONE: When “auth=OPEN” available;
- ◇ AES: When “auth=WPA2PSK” available;

- ◆ key: security code, ASCII code, smaller than 64bit and bigger than 8 bit;

4.2.2.32. AT+WADHCP

- Function: Set/Query AP DHCP server status; Setting is valid after reset.

- Format:

- ◆ Query Operation

AT+WADHCP<CR>

+ok=<status>,<ip1>,<ip2><CR><LF><CR><LF>

- ◆ Set Operation

AT+WADHCP=<status>[,ip1,ip2]<CR>

+ok<CR><LF><CR><LF>

- Parameters:
 - ◆ status: AP's DHCP server function status:
 - ✧ on: DHCP Server Open;
 - ✧ off: DHCP Server Close;
 - ◆ ip1: DHCP allocate IP start value.
 - ◆ ip2: DHCP allocate IP end value.

4.2.2.33. AT+WALK

- Function: Query MAC address of STA device connecting to module AP
- Format:
 - ◆ Query Operation

AT+WALK<CR>

+ok=<status> <CR><LF><CR><LF>

- Parameters:
 - ◆ status: MAC address of STA device connecting to module AP.
 - ✧ No Connection: No STA device connecting to module AP;

4.2.2.34. AT+WALKIND

- Function: Enable/Disable indication of module AP connection status.
- Format:
 - ◆ Query Operation

AT+WALKIND<CR>

+ok=<status> <CR><LF><CR><LF>

- ◆ Set Operation

AT+WALKIND=<status><CR>

+ok<CR><LF><CR><LF>

- Parameters:
 - ◆ status: indication of module AP connection status.
 - ✧ on: Enable nLink indication function. When STA device connecting to module AP, nLink output Low, otherwise output High.
 - ✧ off: Disable nLink indication function. **(default mode)**.

4.2.2.35. AT+WAPMXSTA

- Function: Set/Query max STA number supported for AP.
- Format:
 - ◆ Query Operation

AT+WAPMXSTA<CR>

+ok=<num> <CR><LF><CR><LF>

- ◆ Set Operation

AT+WAPMXSTA=<num><CR>

+ok<CR><LF><CR><LF>

- Parameters:

- ◆ num: max STA number supported for AP.
 - ◇ 1~4: Support max 1~4 STA devices connects to module AP. **0 is default value for max 1 STA device supported.**

4.2.2.36. AT+OTA

- Function: Set OTA Upgrade
- Format:
 - ◆ Set Operation

AT+OTA<CR>

+ok=<CR><LF><CR><LF>

Note: See Appendix C Module Upgrade for detail

4.2.2.37. AT+UPURL

- Function: Set/ Query remote upgrade URL address;
 - Format:
 - ◆ Query Operation
- AT+UPURL<CR>**
- +ok=<url> <CR><LF><CR><LF>**
- ◆ Set Operation
- AT+UPURL=<url,filename> <CR>**
- +ok<CR><LF><CR><LF>**
- Parameters:
 - ◆ url: the upgrade file url address; the last charter shall be "/" (within 20 characters).
 - ◆ filename: the upgrade file name, it's optional and not saved parameter. If provide this file name here, the module will start upgrade right away;

4.2.2.38. AT+DISPS

- Function: Set/Query power save parameters;
 - Format:
 - ◆ Query Operation
- AT+DISPS<CR>**
- +ok=<ret><CR><LF><CR><LF>**
- ◆ Set Operation
- AT+DISPS=<mode[,time]><CR><LF><CR><LF>**
- Parameters:
 - ◆ ret:
 - ◇ No: Enable power save
 - ◇ Yes: Disable power save
 - ◇ Auto: Auto power save mode(default), enter power saving mode after receive or send data in time seconds.
 - ◆ mode:
 - ◇ No: Enable power save
 - ◇ Yes: Disable power save

- ✧ Auto: Auto power save mode(default), enter power saving mode after receive or send data in time seconds.
- ◆ time: Only valid in auto mode, >=2 integer value, default is 3 seconds. when value is 0, the default waiting time is still 3 seconds.

4.2.2.39. AT+PLANG

- Function: Set/Query webpage language option;
- Format:
 - ◆ Query Operation

```
AT+PLANG<CR>
+ok=<language> <CR><LF><CR><LF>
```
 - ◆ Set Operation

```
AT+PLANG=<language> <CR>
+ok<CR><LF><CR><LF>
```
- Parameters:
 - ◆ language: webpage's language
 - ✧ CN: Chinese Version (Default);
 - ✧ EN: English Version;

4.2.2.40. AT+WEBU

- Function: Set/ Query webpage user name and password; Setting is valid after reset.
- Format:
 - ◆ Query Operation

```
AT+WEBU<CR>
+ok=<username,password> <CR><LF><CR><LF>
```
 - ◆ Set Operation

```
AT+WEBU=<username,password><CR>
+ok<CR><LF><CR><LF>
```
- Parameters:
 - ◆ username: User Name, within 15 characters, not support empty.
 - ◆ password: password, within 15 characters, support empty.

4.2.2.41. AT+WRMID

- Function: Set module ID;
- Format:
 - ◆ Set Operation

```
AT+WRMID=<wrmid> <CR><LF><CR><LF>
```
- Parameters:
 - ◆ wrmid: set module's ID (within 20 characters).

4.2.2.42. AT+ASWD

- Function: Set/Query WiFi Configuration Password;
- Format:
 - ◆ Query Operation

```
AT+ASWD<CR>
```

+ok=<aswd> <CR><LF><CR><LF>

- ◆ Set Operation

AT+ASWD=<aswd> <CR><LF><CR><LF>

- Parameters:
 - ◆ aswd: WiFi Configuration Password (within 20 characters).

4.2.2.43. AT+SMTLK

- Function: Start SmartLink function
- Format:
 - ◆ Query Operation

AT+SMTLK<CR>

SmartLink is a One-Key config function. Config the module connecting to router easily. After start SmartLink function, the module work in SmartLink status and nLink LED is fast flashing waiting for APP to push information. See the Appendix for more details.

4.2.2.44. AT+SMEM

- Function: Query the RAM status.
- Format:
 - ◆ Query Operation

AT+SMEM<CR>

+ok=<status> <CR><LF><CR><LF>

- Parameters:
 - ◆ status: The RAM status, the last number is the free memory size can be used.

```
AT+SMEM
+ok=mem:6624,6624,0,46324
uart send:0
uart recv:12
uart buffer full:0
socketa send:0
socketa recv:0
socketa buffer full:0
```

4.2.2.45. AT+NDBGL

- Function: Enable/Disable UART debug information
- Format:
 - ◆ Query Operation

AT+NDBGL<CR>

+ok=<debug_level,uart_num> <CR><LF><CR><LF>

- ◆ Set Operation

AT+NDBGL =<debug_level,uart_num><CR>

+ok<CR><LF><CR><LF>

- Parameters:
 - ◆ debug_level: UART debug level value
 - ◇ 0: Disable debug information output
 - ◇ 1~XX: Output UART debug information which is with the same(and above) debug level value

- ◆ uart_level: UART debug information output channel
 - ◇ 0: UART0
 - ◇ 1: UART1

High-Flying

5. PACKAGE INFORMATION

5.1. Recommended Reflow Profile

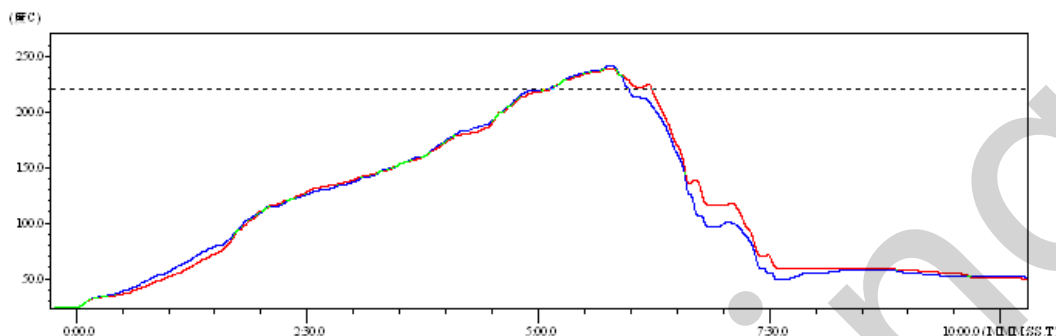

Figure 34. Reflow Soldering Profile

Table9. Reflow Soldering Parameter

NO.	Item	Temperature (Degree)	Time(Sec)
1	Reflow Time	Time of above 220	35~55 sec
2	Peak-Temp	260 max	

- Note:** 1. Recommend to supply N2 for reflow oven.
 2. N2 atmosphere during reflow (O2<300ppm)

5.2. Device Handling Instruction (Module IC SMT Preparation)

- Shelf life in sealed bag: 12 months, at <30°C and <60% relative humidity (RH)
- After bag is opened, devices that will be re-baked required after last baked with window time 168 hours.
- Recommend to oven bake with N2 supplied
- Recommend end to reflow oven with N2 supplied
- Baked required with 24 hours at 125±5°C before rework process for two modules, one is new module and two is board with module
- Recommend to store at ≦ 10% RH with vacuum packing
- If SMT process needs twice reflow:
 - Top side SMT and reflow
 - Bottom side SMT and reflow

Case 1: Wifi module mounted on top side. Need to bake when bottom side process over 168 hours window time, no need to bake within 168 hours

Case 2: Wifi module mounted on bottom side, follow normal bake rule before process

Note: Window time means from last bake end to next reflow start that has 168 hours space.

5.3. Shipping Information

TAPE

Size: 370*270*15 mm



BOX

Size: 370*270*60 mm (inside)



Figure 35. Shipping Information

Note:

1 tape = 60 pcs

1 box = 3~4 tapes = 3~4 * 60 pcs = 180~240pcs

APPENDIX A: HTTP PROTOCOL TRANSFER

HF-LPT120 module support http data transfer in throughput mode. If any detailed HTTP protocol, contact us and we may support customization.

A.1. Sending HTTP Raw Data in Throughput Mode

Step 1、 Configure HTTP server information

```
AT+NETP=tcp,client,80,testnewjava.gotoip4.com
+ok
```

Step 2、 Configure module connecting to router AP and reboot.

```
AT+WSSSID=Tenda_GYH
+ok

AT+WSKEY=wpa2psk,aes,12345678
+ok

AT+WMODE=sta
+ok

AT+Z
```

Step 3、 Sending HTTP raw data via UART, end the data with<CR><LF><CR><LF>



APPENDIX B: REFERENCES

B.1. High-Flying Mass Production Tool

Download Address: http://www.hi-flying.com/download_detail_dc/downloadsId=9.html

B.2. SmartLink APP V7 Config Tool

IOS Platform : http://www.hi-flying.com/download_detail_dc/downloadsId=42.html

Android Platform: http://www.hi-flying.com/download_detail_dc/downloadsId=83.html

B.3. EVK Quick Start Guide

Download Address: <http://www.hi-flying.com/downloadsfront.do?method=picker&flag=all&id=a974580c-9a9b-4329-a554-6bd54aa8500d&fileId=99>

B.4. Module Upgrade

Download Address: http://www.hi-flying.com/download_detail_fir/downloadsId=75.html

B.5. Other Tools

Download Address: http://www.hi-flying.com/download_list_dc/&downloadcategoryid=14&isMode=false&comp_stats=comp-FrontDownloadsCategory_show01-1376450727769.html

APPENDIX C: CONTACT INFORMATION

Address: [Room 1002, Building 1, No.3000, Longdong Avenue, Pudong New Area, Shanghai, China, 201203](#)

Web: www.hi-flying.com

Service Online: [400-189-3108/18616078755](tel:400-189-3108/18616078755)

Sales Contact: sales@hi-flying.com

For more information about High-Flying modules, applications, and solutions, please visit our web site <http://www.hi-flying.com/en/>

<END OF DOCUMENT>

© Copyright High-Flying, May, 2011

The information disclosed herein is proprietary to High-Flying and is not to be used by or disclosed to unauthorized persons without the written consent of High-Flying. The recipient of this document shall respect the security status of the information.

The master of this document is stored on an electronic database and is "write-protected" and may be altered only by authorized persons at High-Flying. Viewing of the master document electronically on electronic database ensures access to the current issue. Any other copies must be regarded as uncontrolled copies.